

## PHC M28A50X5M SKF

Conveyor chain

TYPE: Conveyor chain, Type M, with bush (SKF)

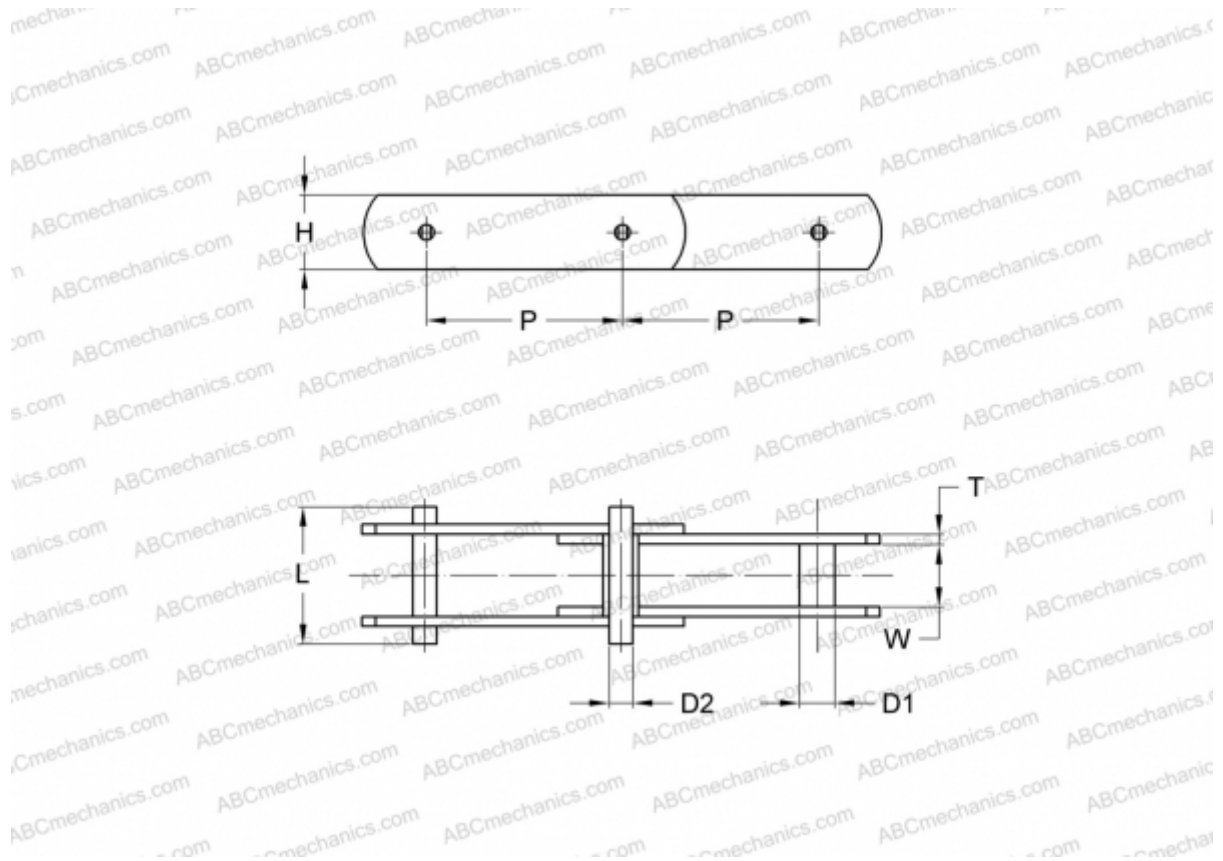

### Technical specification

#### DIMENSIONS, MM

P	50,000
D1	10,000
W	18,000
D2	7,000
H	21,000
T	3,000
L	40,000

**MANUFACTURER** [SKF](#)

**DESIGNATION BS/ISO:** M28A