

## PHC M112A125X5M SKF

Conveyor chain

TYPE: Conveyor chain, Type M, with bush (SKF)

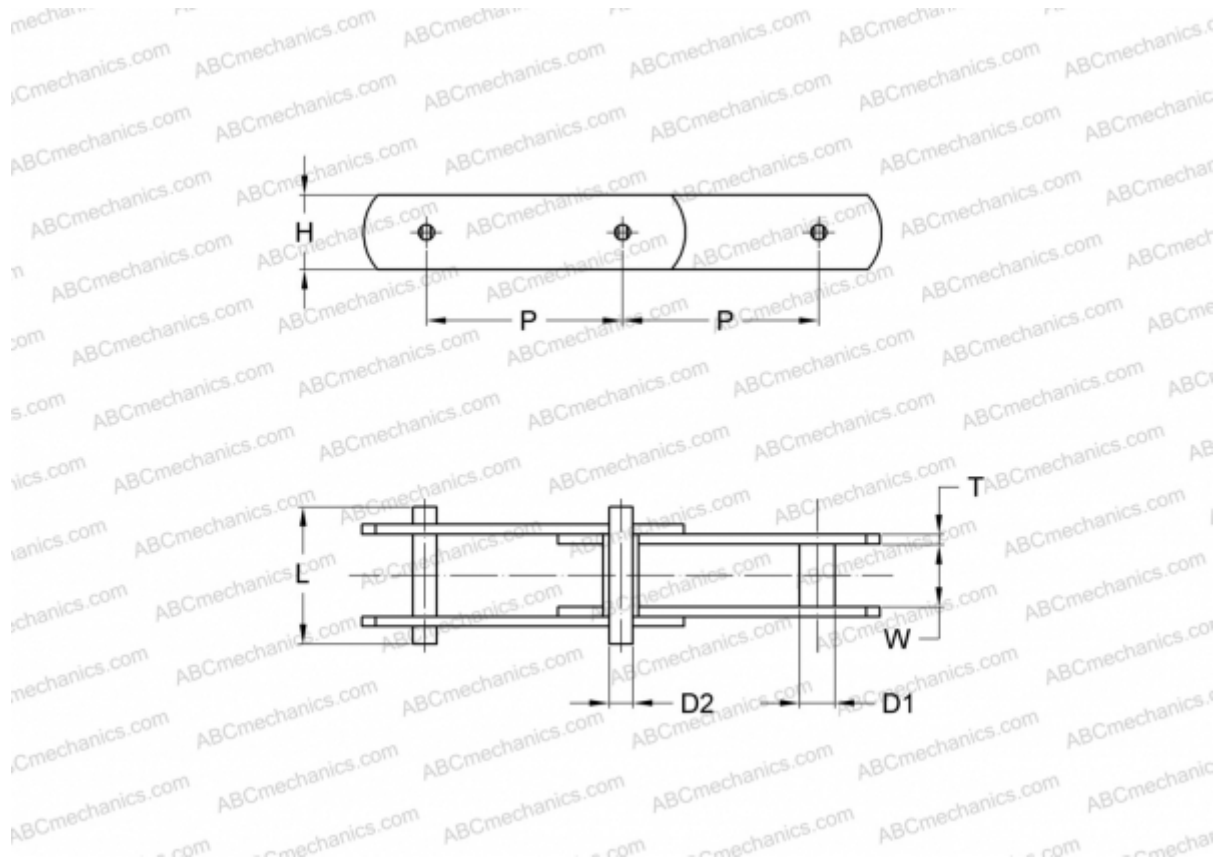

### Technical specification

#### DIMENSIONS, MM

P	125,000
D1	21,000
W	32,000
D2	15,000
H	41,000
T	6,000
L	73,000

**MANUFACTURER** [SKF](#)

**DESIGNATION BS/ISO:** M112A