

PHC M20A125X10FT SKF

Conveyor chain

TYPE: Conveyor chain, Type M, with bush (SKF)

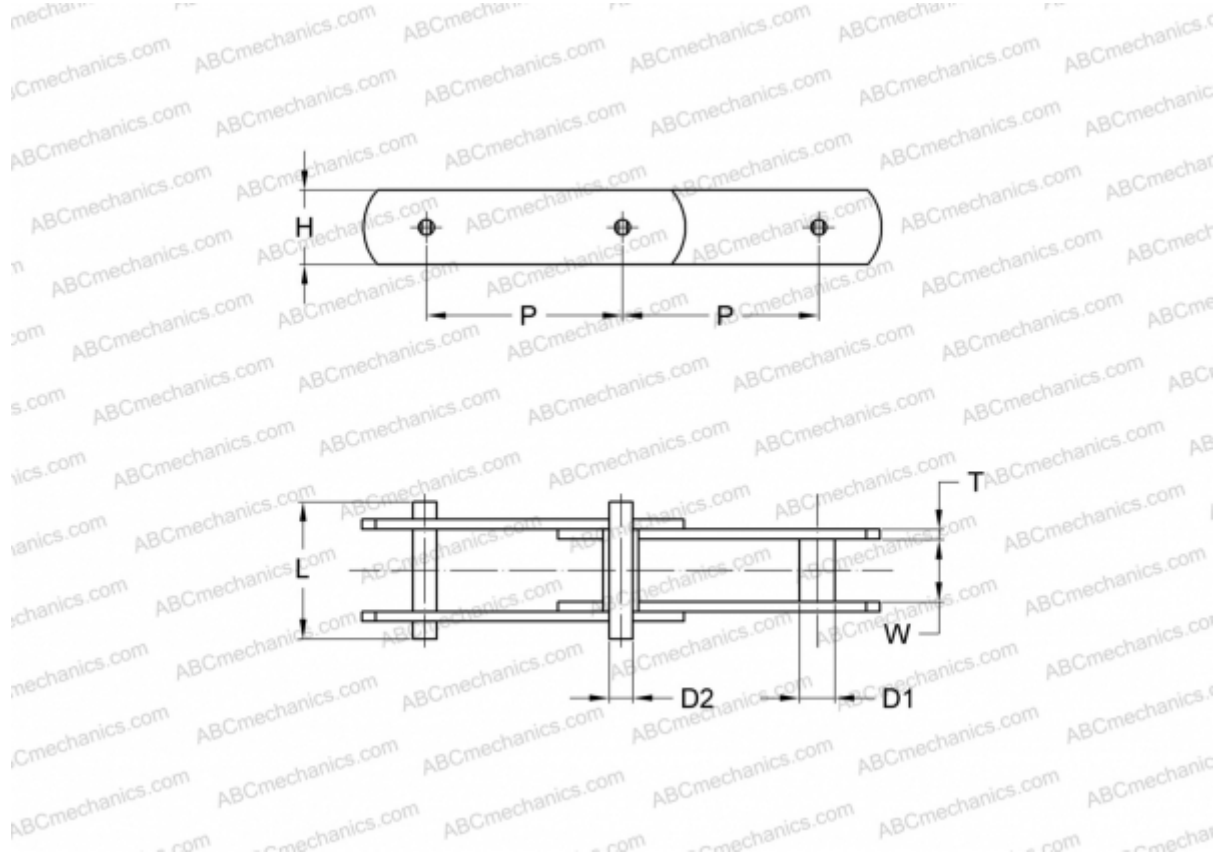

Technical specification

DIMENSIONS, MM

| | |
|----|---------|
| P | 125,000 |
| D1 | 9,000 |
| W | 16,000 |
| D2 | 6,000 |
| H | 19,000 |
| T | 2,500 |
| L | 35,000 |

MANUFACTURER [SKF](#)

DESIGNATION BS/ISO: M20A