

## PHC M40A100X10FT SKF

Conveyor chain

TYPE: Conveyor chain, Type M, with bush (SKF)

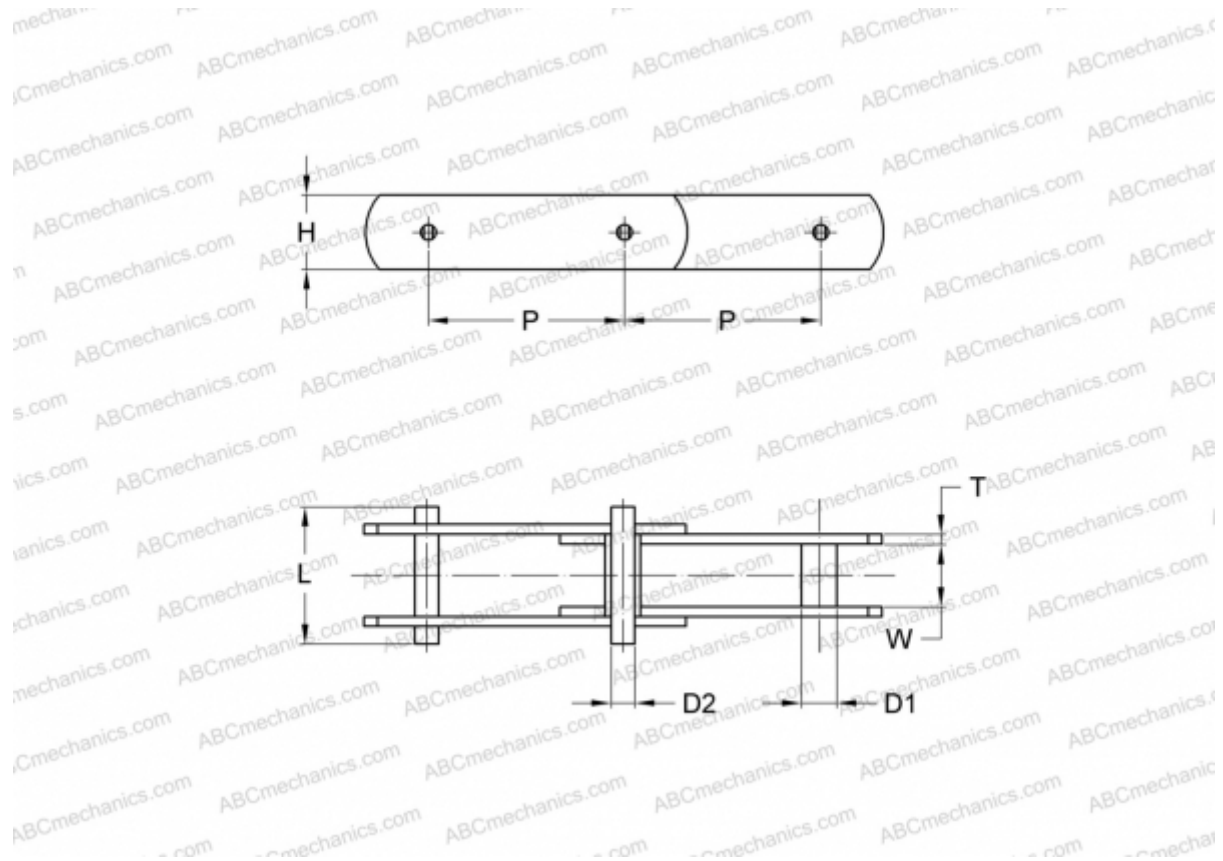

### Technical specification

#### DIMENSIONS, MM

P	100,000
D1	12,500
W	20,000
D2	8,500
H	26,000
T	3,500
L	45,000

**MANUFACTURER** [SKF](#)

**DESIGNATION BS/ISO:** M40A