

## PHC M80A100X10FT SKF

Conveyor chain

TYPE: Conveyor chain, Type M, with bush (SKF)

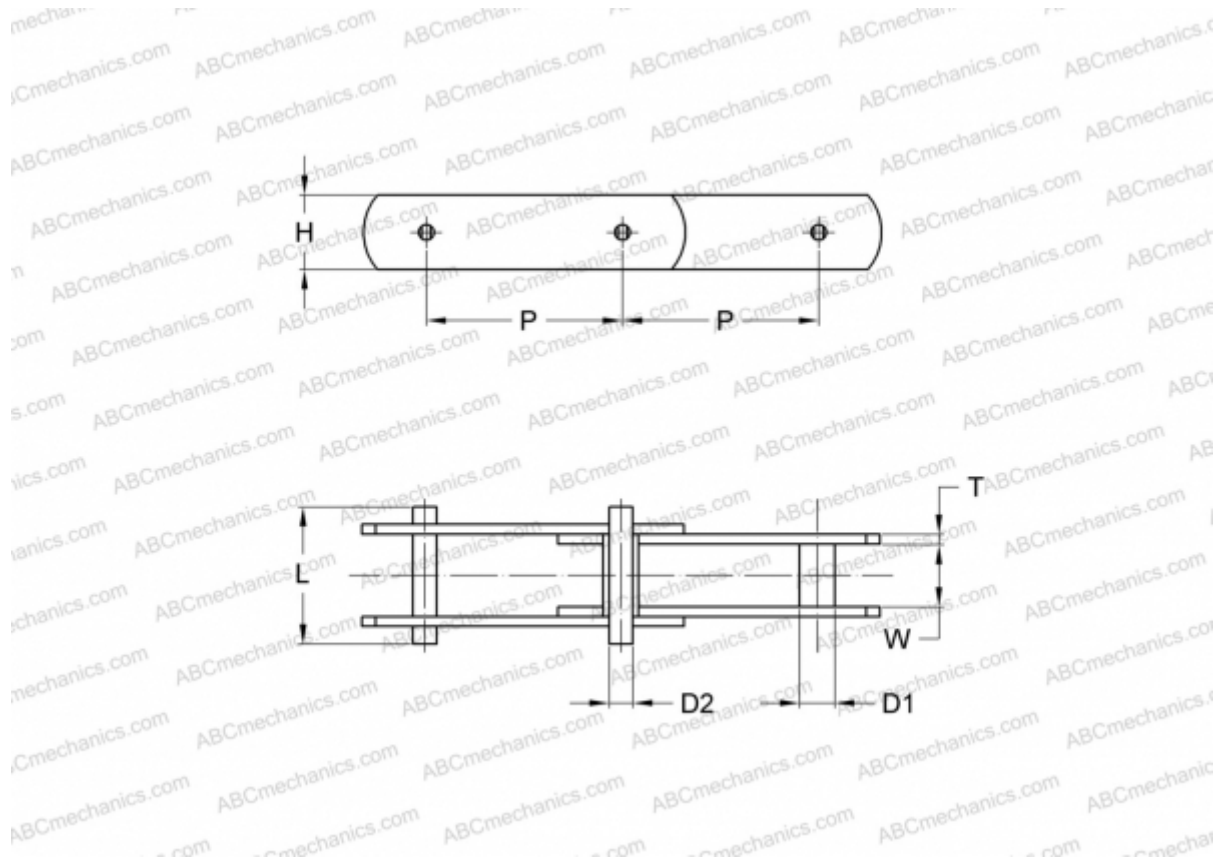

### Technical specification

#### DIMENSIONS, MM

P	100,000
D1	18,000
W	28,000
D2	12,000
H	36,000
T	5,000
L	62,000

**MANUFACTURER** [SKF](#)

**DESIGNATION BS/ISO:** M80A