

PHC M160A500X10FT SKF

Conveyor chain

TYPE: Conveyor chain, Type M, with bush (SKF)

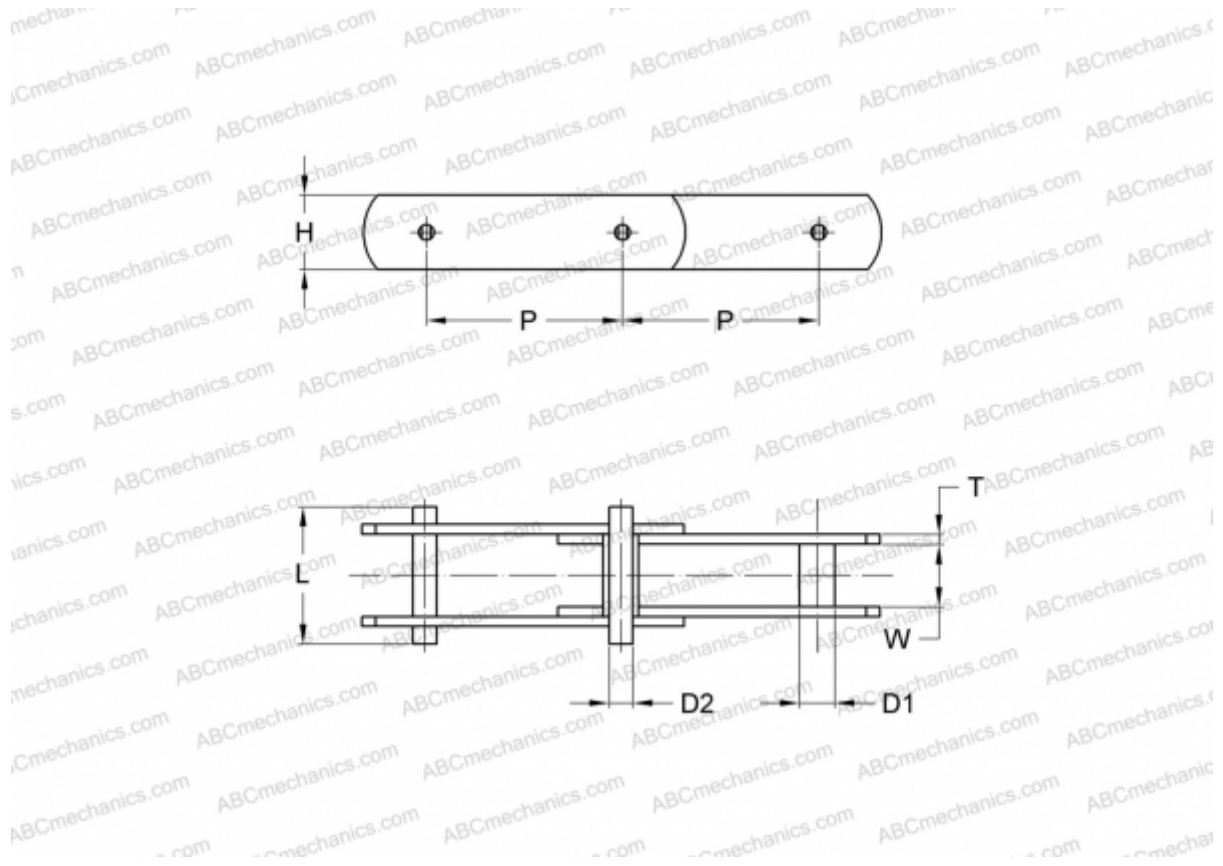

Technical specification

DIMENSIONS, MM

P	500,000
D1	25,000
W	37,000
D2	18,000
H	51,000
T	7,000
L	85,000

MANUFACTURER [SKF](#)

DESIGNATION BS/ISO: M160A