

PHC M450A800X10FT SKF

Conveyor chain

TYPE: Conveyor chain, Type M, with bush (SKF)

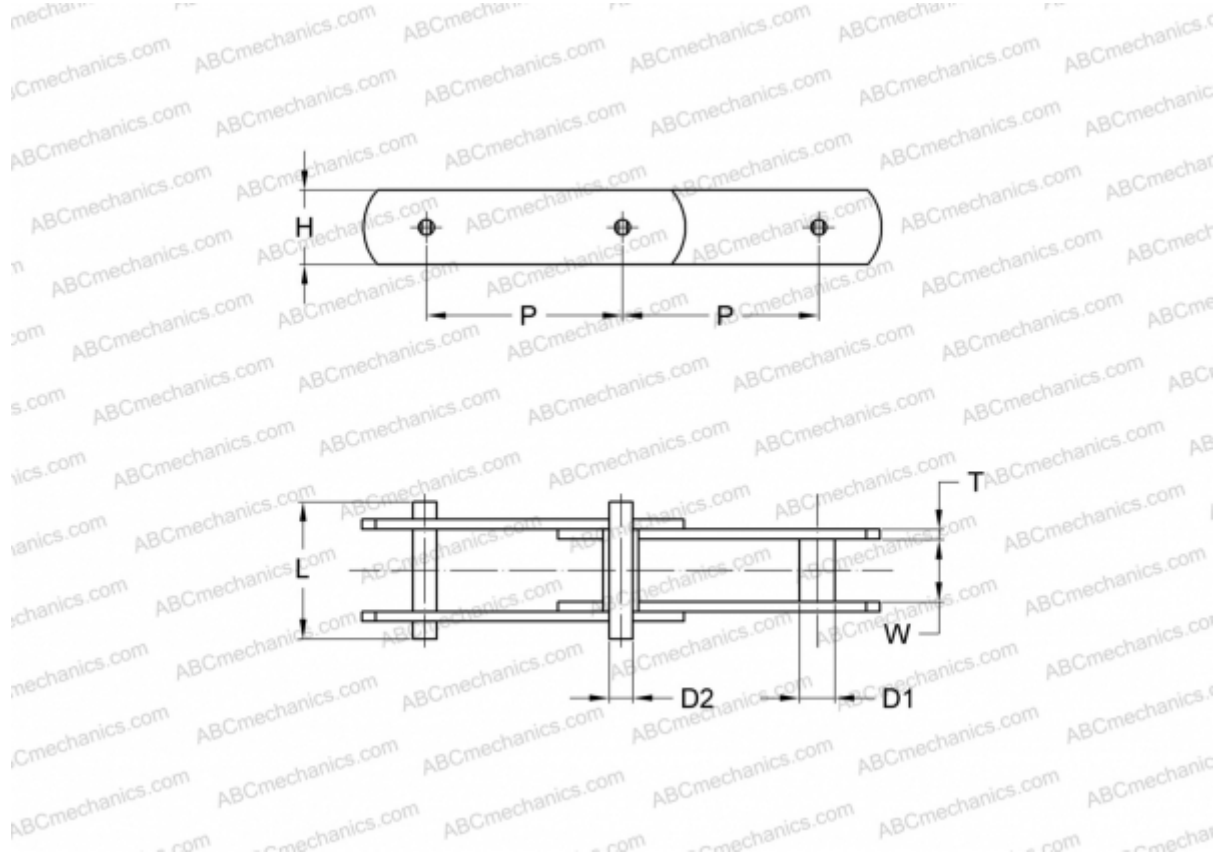

Technical specification

DIMENSIONS, MM

P	800,000
D1	42,000
W	56,000
D2	30,000
H	82,000
T	12,000
L	135,000

MANUFACTURER [SKF](#)

DESIGNATION BS/ISO: M450A