

## PHC M450S400X5M SKF

Conveyor chain

TYPE: Conveyor chain, Type M, roller (SKF)

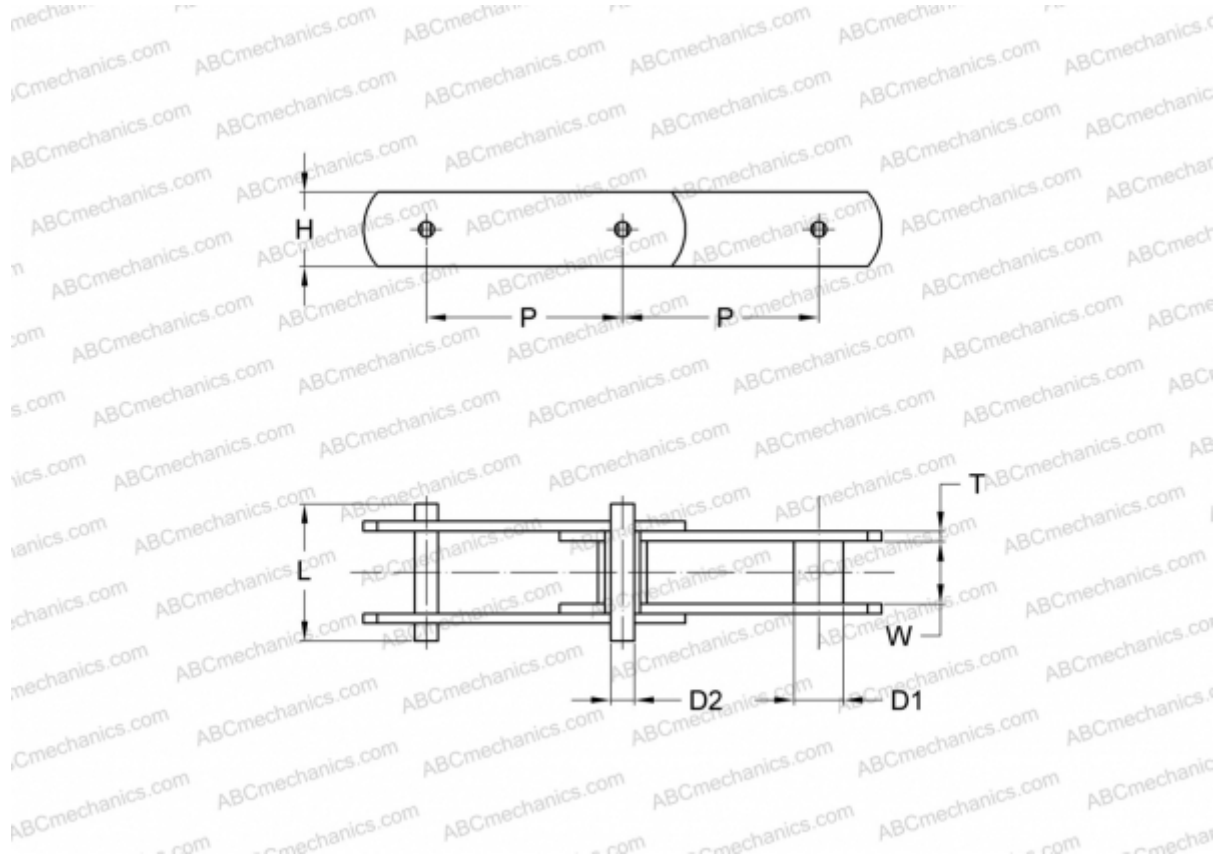

### Technical specification

#### DIMENSIONS, MM

P	400,000
D1	42,000
W	56,000
D2	30,000
H	82,000
T	12,000
L	135,000

**MANUFACTURER** [SKF](#)

**DESIGNATION BS/ISO:** M450S