

## PHC M20S50X10FT SKF

Conveyor chain

TYPE: Conveyor chain, Type M, roller (SKF)

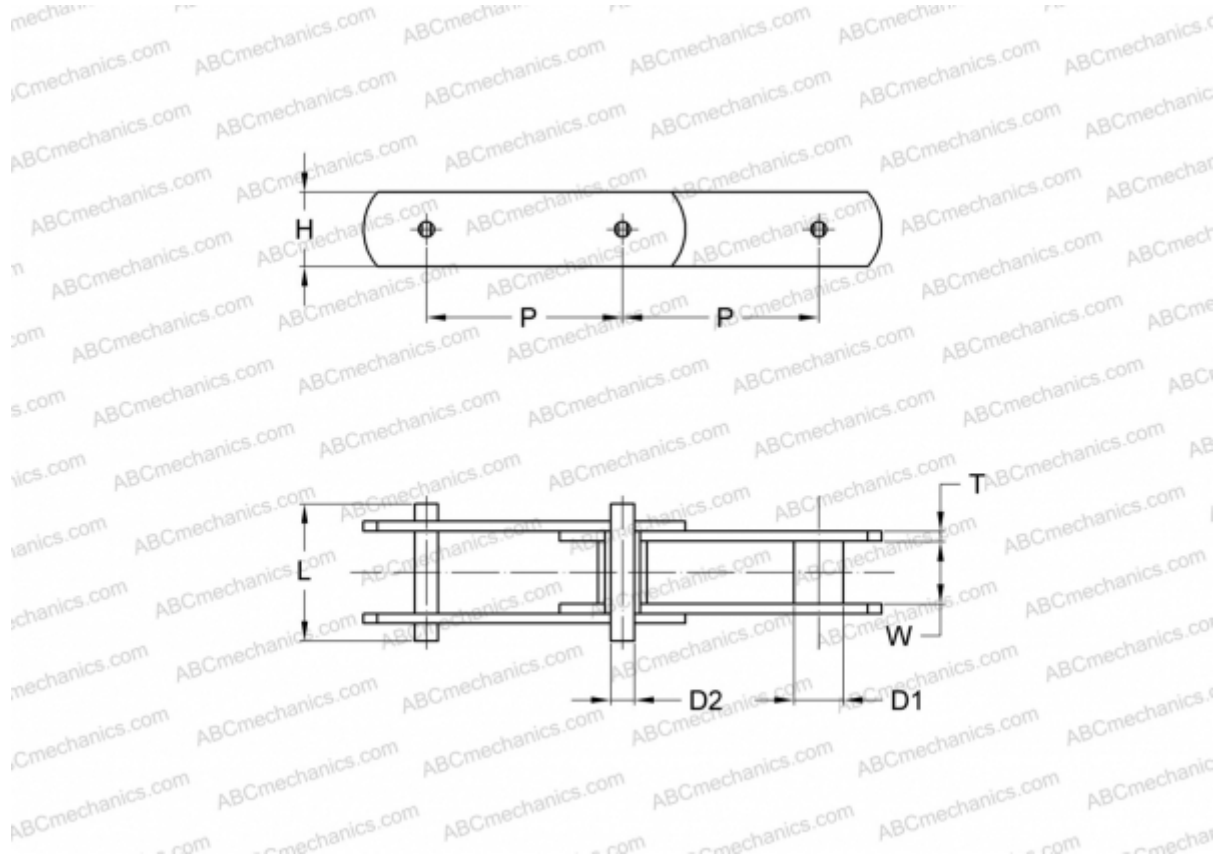

### Technical specification

#### DIMENSIONS, MM

P	50,000
D1	9,000
W	16,000
D2	6,000
H	19,000
T	2,500
L	35,000

**MANUFACTURER** [SKF](#)

**DESIGNATION BS/ISO:** M20S