

PHC M40S63X10FT SKF

Conveyor chain

TYPE: Conveyor chain, Type M, roller (SKF)

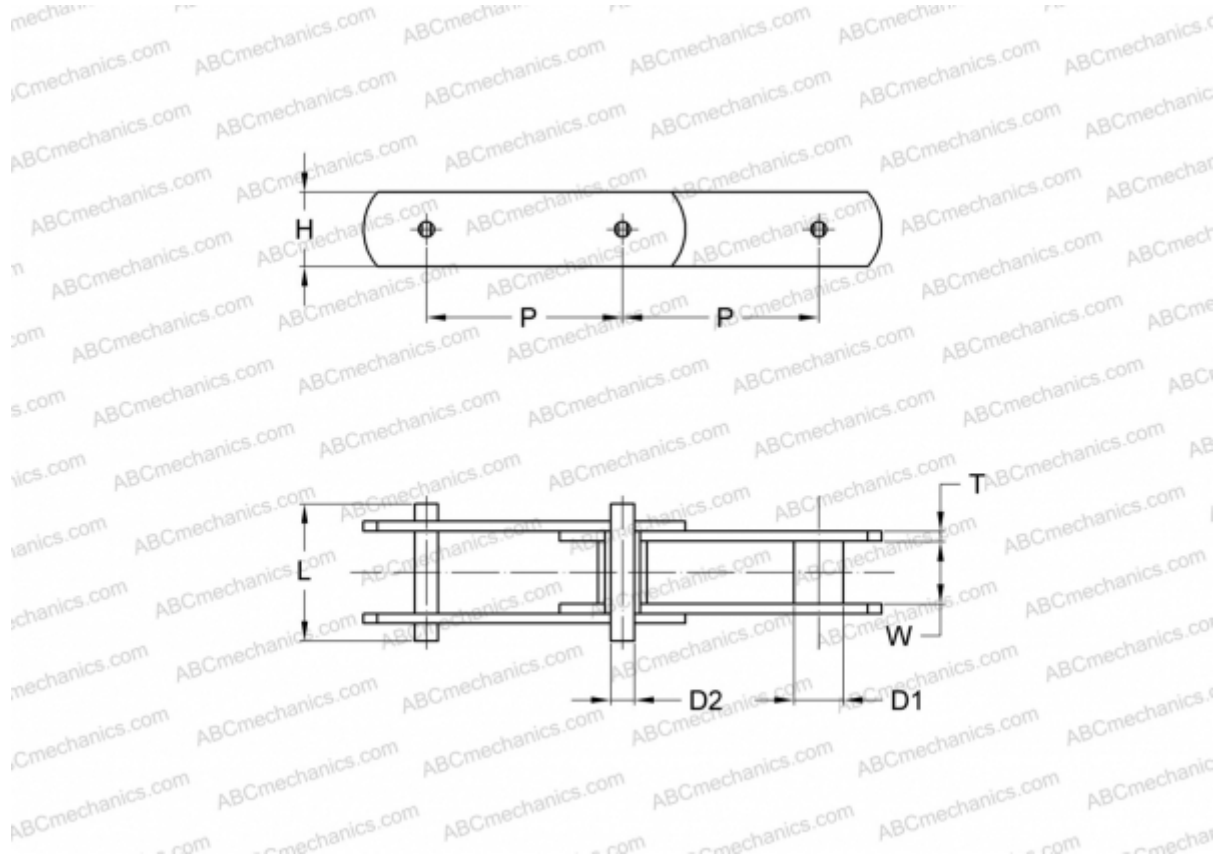

Technical specification

DIMENSIONS, MM

P	63,000
D1	12,500
W	20,000
D2	8,500
H	26,000
T	3,500
L	45,000

MANUFACTURER [SKF](#)

DESIGNATION BS/ISO: M40S