

PHC M56S125X10FT SKF

Conveyor chain

TYPE: Conveyor chain, Type M, roller (SKF)

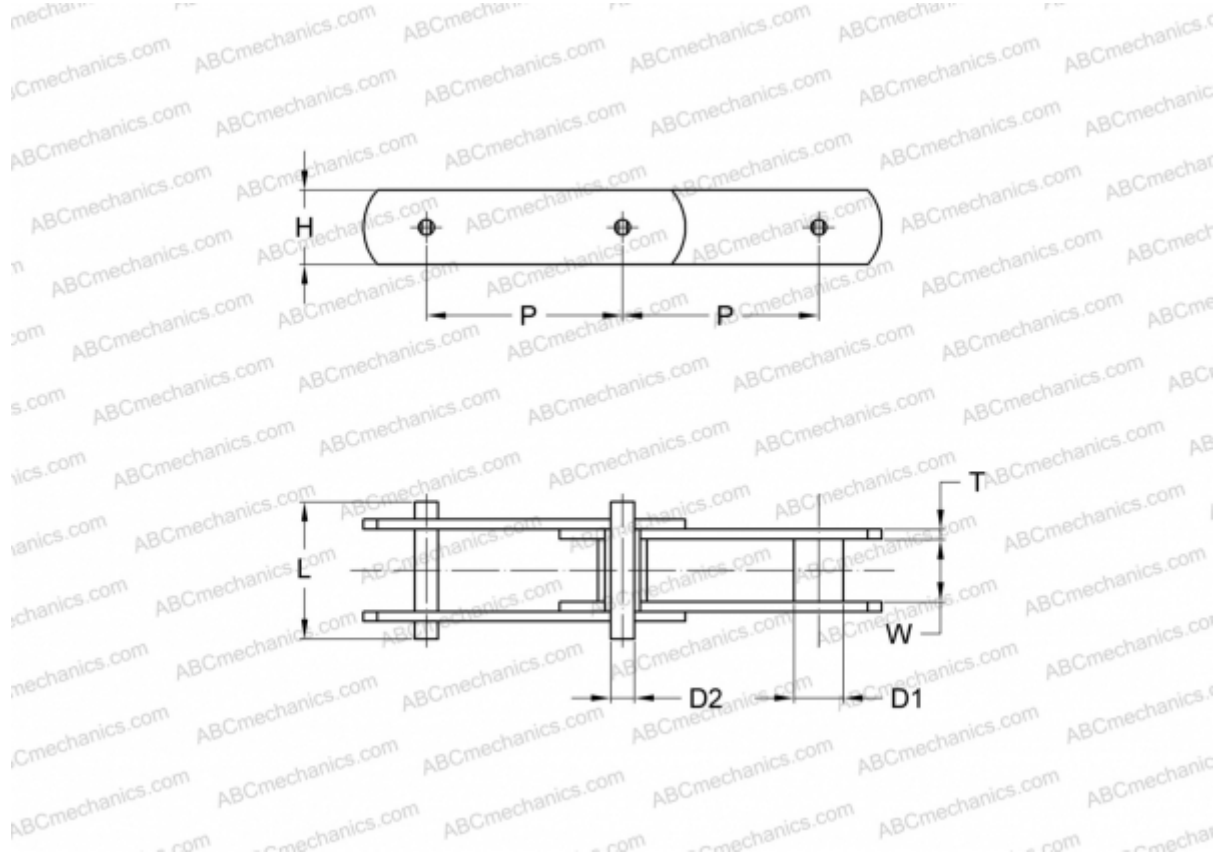

Technical specification

DIMENSIONS, MM

P	125,000
D1	15,000
W	24,000
D2	10,000
H	31,000
T	4,000
L	52,000

MANUFACTURER [SKF](#)

DESIGNATION BS/ISO: M56S