

PHC M112S400X10FT SKF

Conveyor chain

TYPE: Conveyor chain, Type M, roller (SKF)

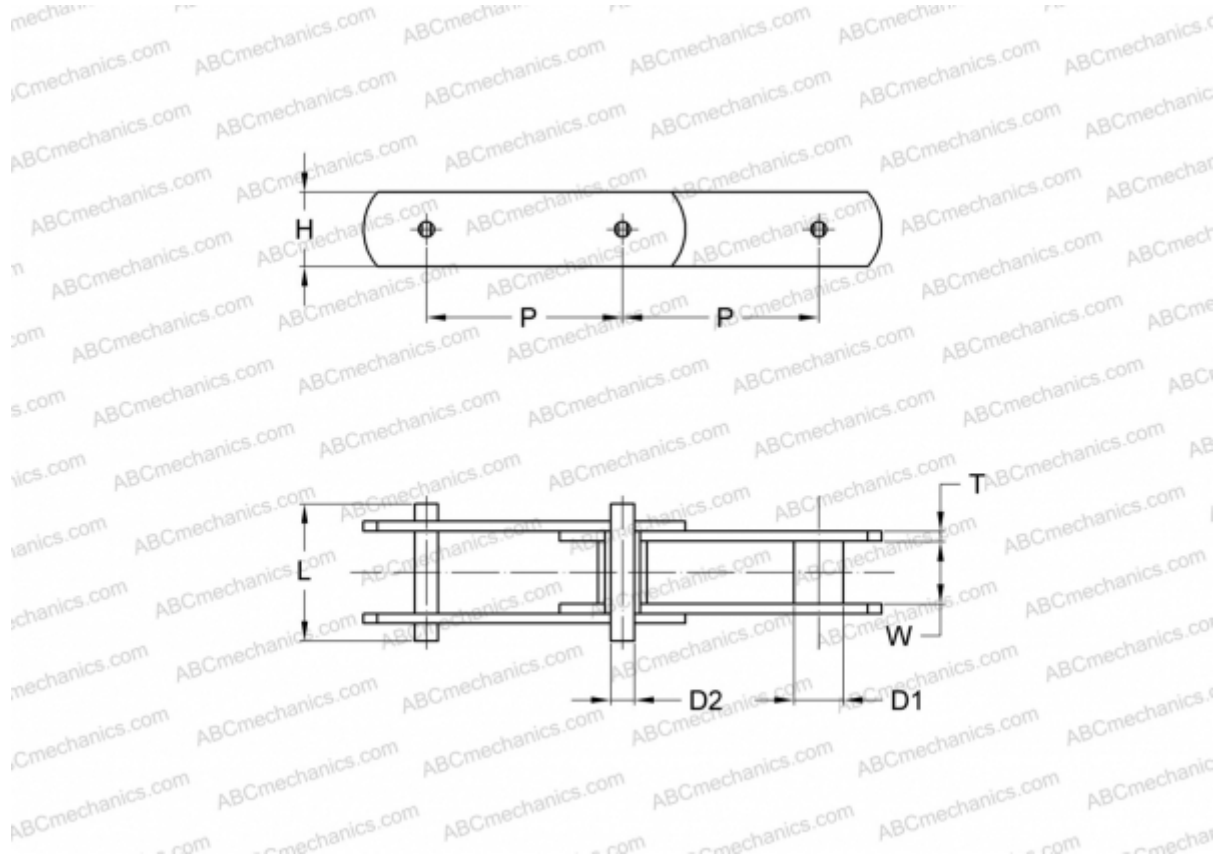

Technical specification

DIMENSIONS, MM

| | |
|----|---------|
| P | 400,000 |
| D1 | 21,000 |
| W | 32,000 |
| D2 | 15,000 |
| H | 41,000 |
| T | 6,000 |
| L | 73,000 |

MANUFACTURER [SKF](#)

DESIGNATION BS/ISO: M112S