

PHC M224S250X10FT SKF

Conveyor chain

TYPE: Conveyor chain, Type M, roller (SKF)

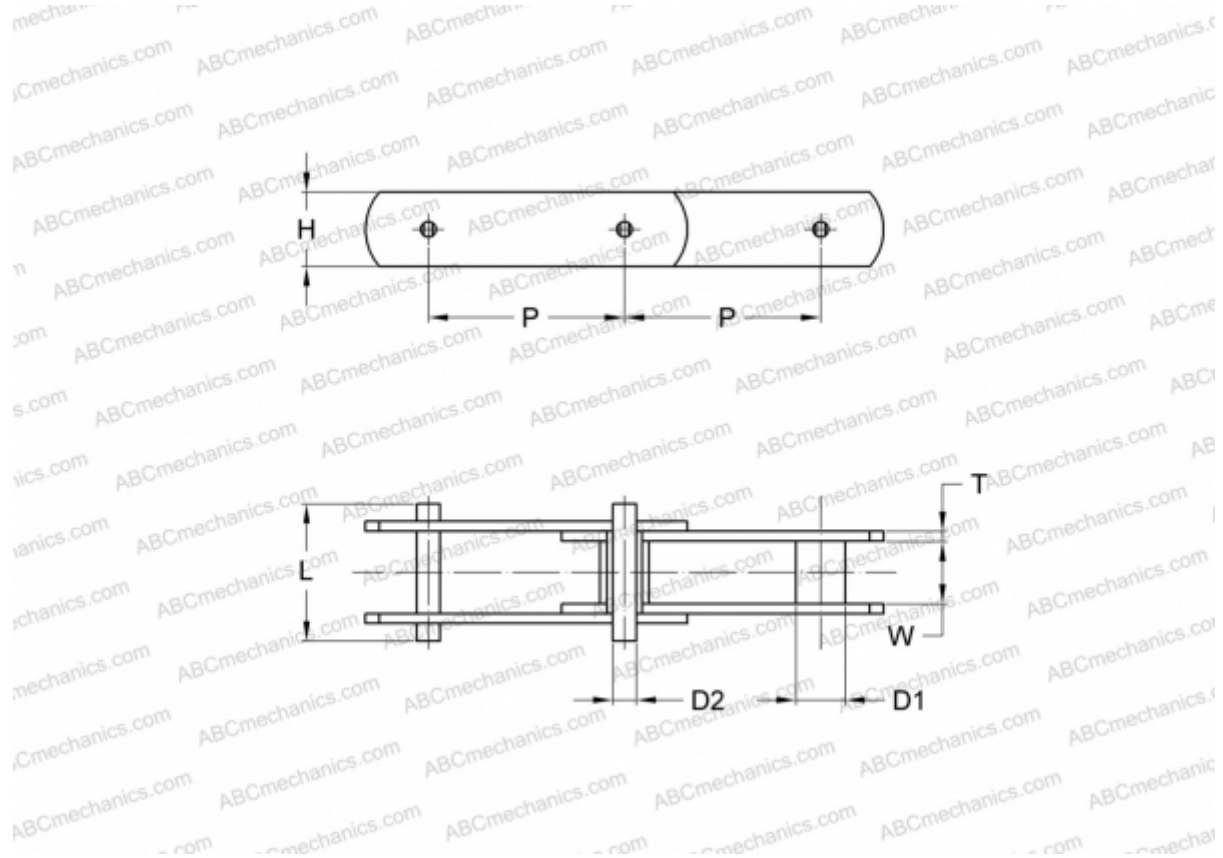

Technical specification

DIMENSIONS, MM

| | |
|----|---------|
| P | 250,000 |
| D1 | 30,000 |
| W | 43,000 |
| D2 | 21,000 |
| H | 62,000 |
| T | 8,000 |
| L | 98,000 |

MANUFACTURER [SKF](#)

DESIGNATION BS/ISO: M224S