

## PHC M56P63X5M SKF

Conveyor chain

TYPE: Conveyor chain, Type M, large roller (SKF)

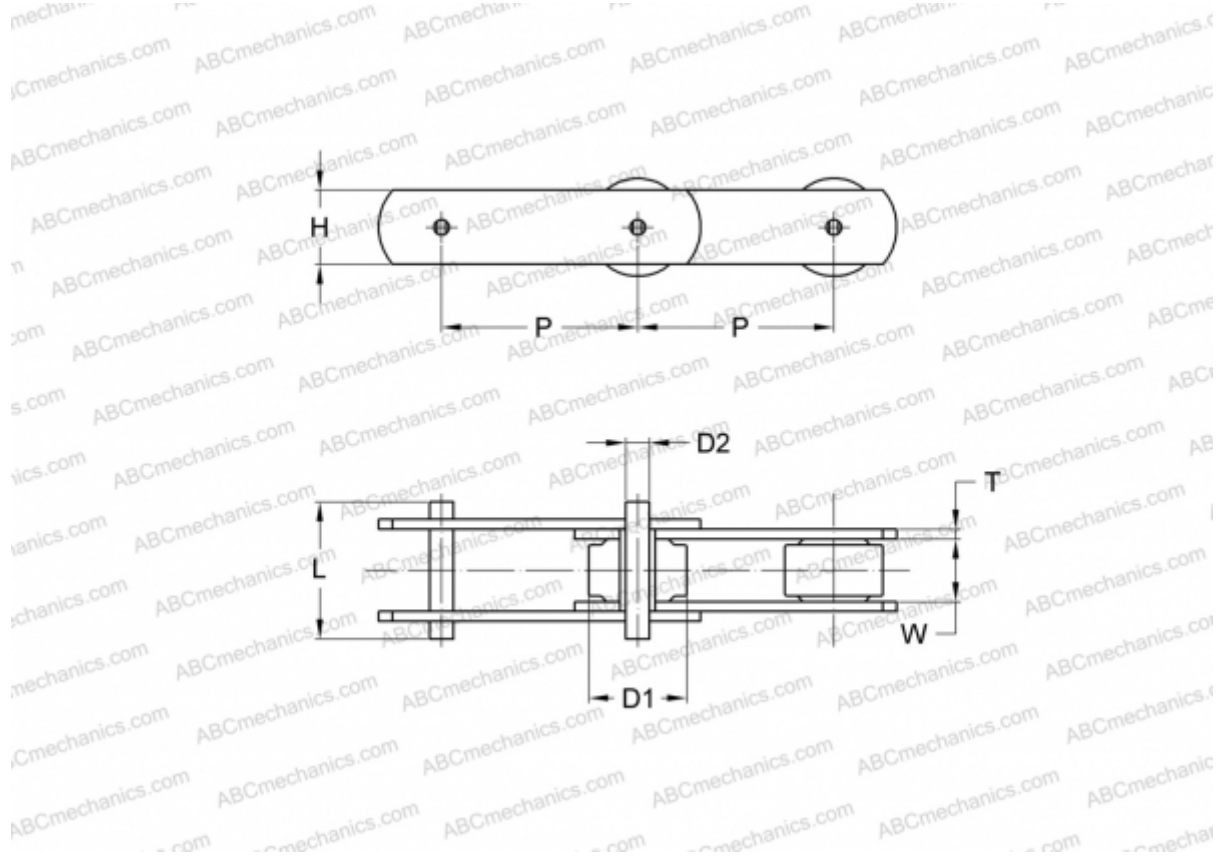

### Technical specification

#### DIMENSIONS, MM

P	63,000
D1	15,000
W	24,000
D2	10,000
H	31,000
T	4,000
L	52,000

**MANUFACTURER** [SKF](#)

**DESIGNATION BS/ISO:** M56P