

PHC M56P160X5M SKF

Conveyor chain

TYPE: Conveyor chain, Type M, large roller (SKF)

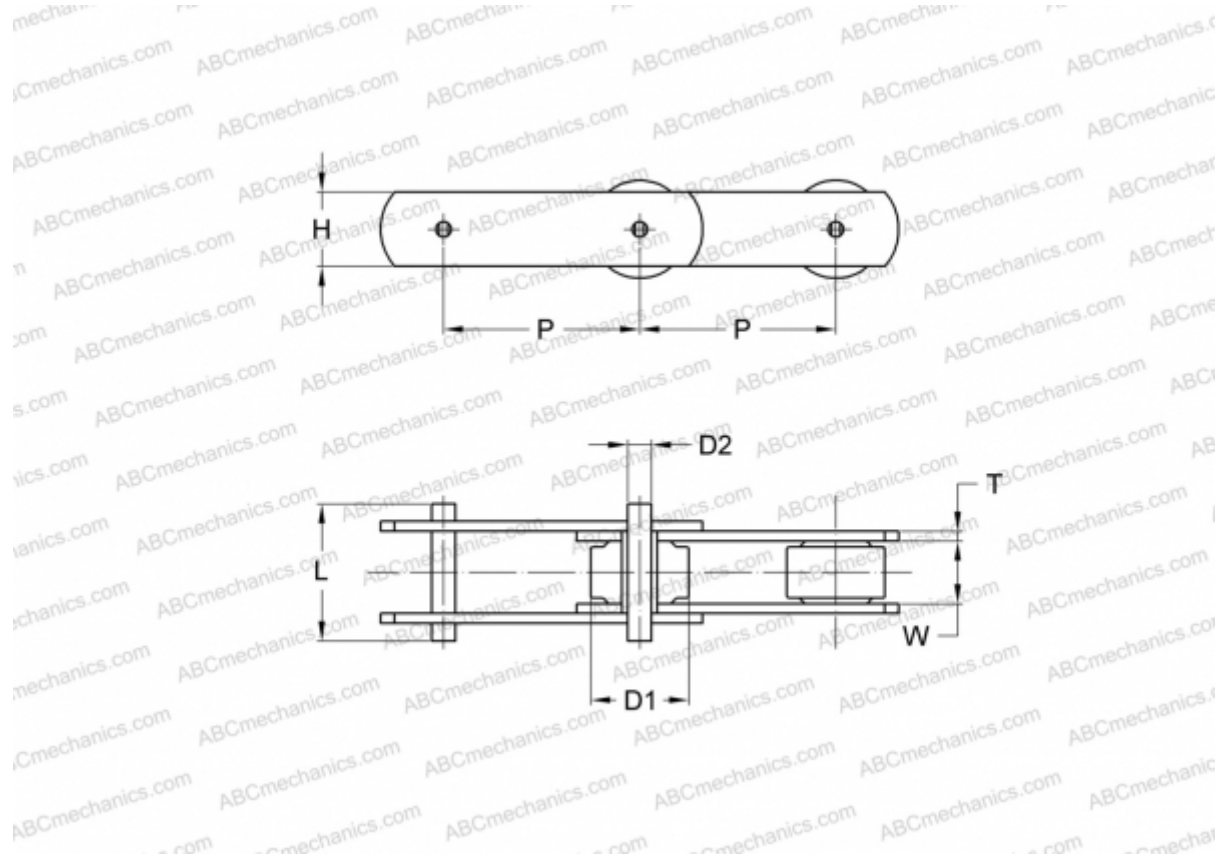

Technical specification

DIMENSIONS, MM

P	160,000
D1	15,000
W	24,000
D2	10,000
H	31,000
T	4,000
L	52,000

MANUFACTURER [SKF](#)

DESIGNATION BS/ISO: M56P