

PHC M80P250X5M SKF

Conveyor chain

TYPE: Conveyor chain, Type M, large roller (SKF)

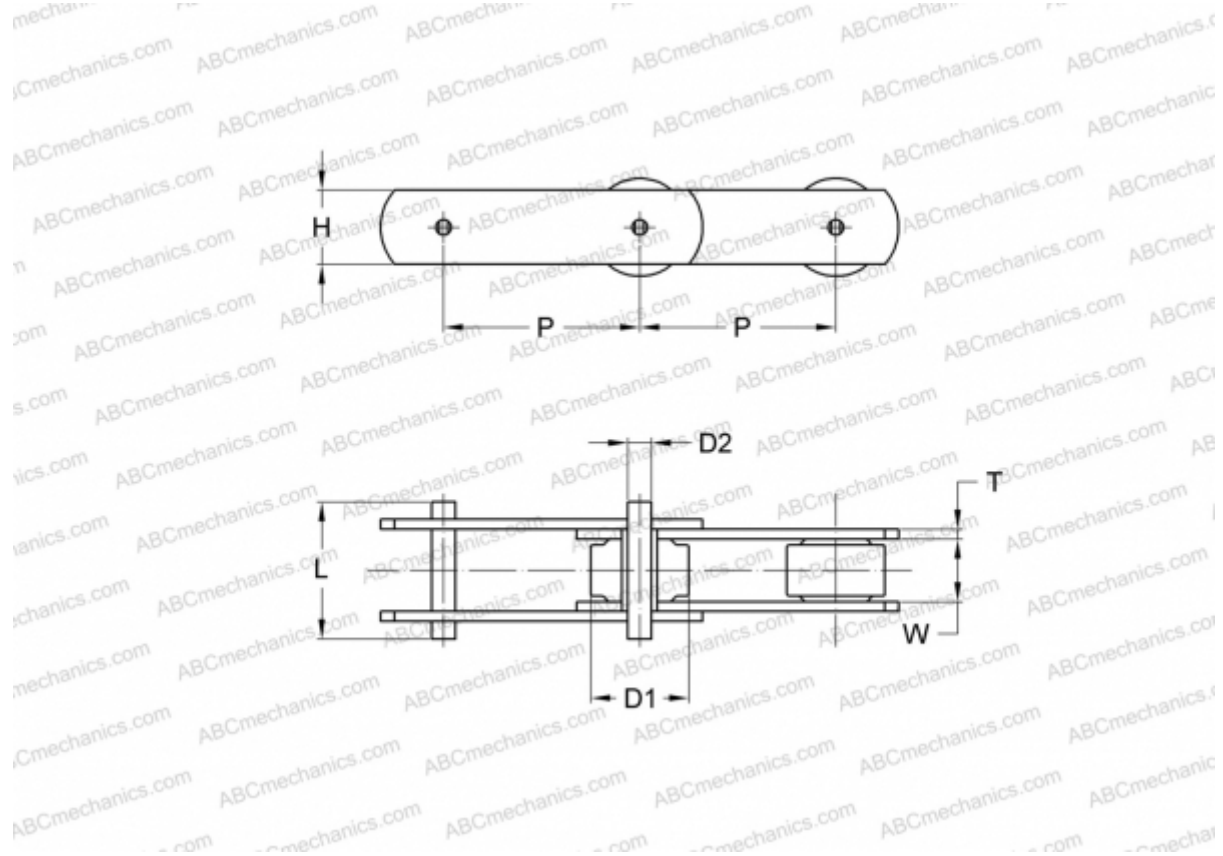

Technical specification

DIMENSIONS, MM

P	250,000
D1	18,000
W	28,000
D2	12,000
H	36,000
T	5,000
L	62,000

MANUFACTURER [SKF](#)

DESIGNATION BS/ISO: M80P