

## PHC M160P500X5M SKF

Conveyor chain

TYPE: Conveyor chain, Type M, large roller (SKF)

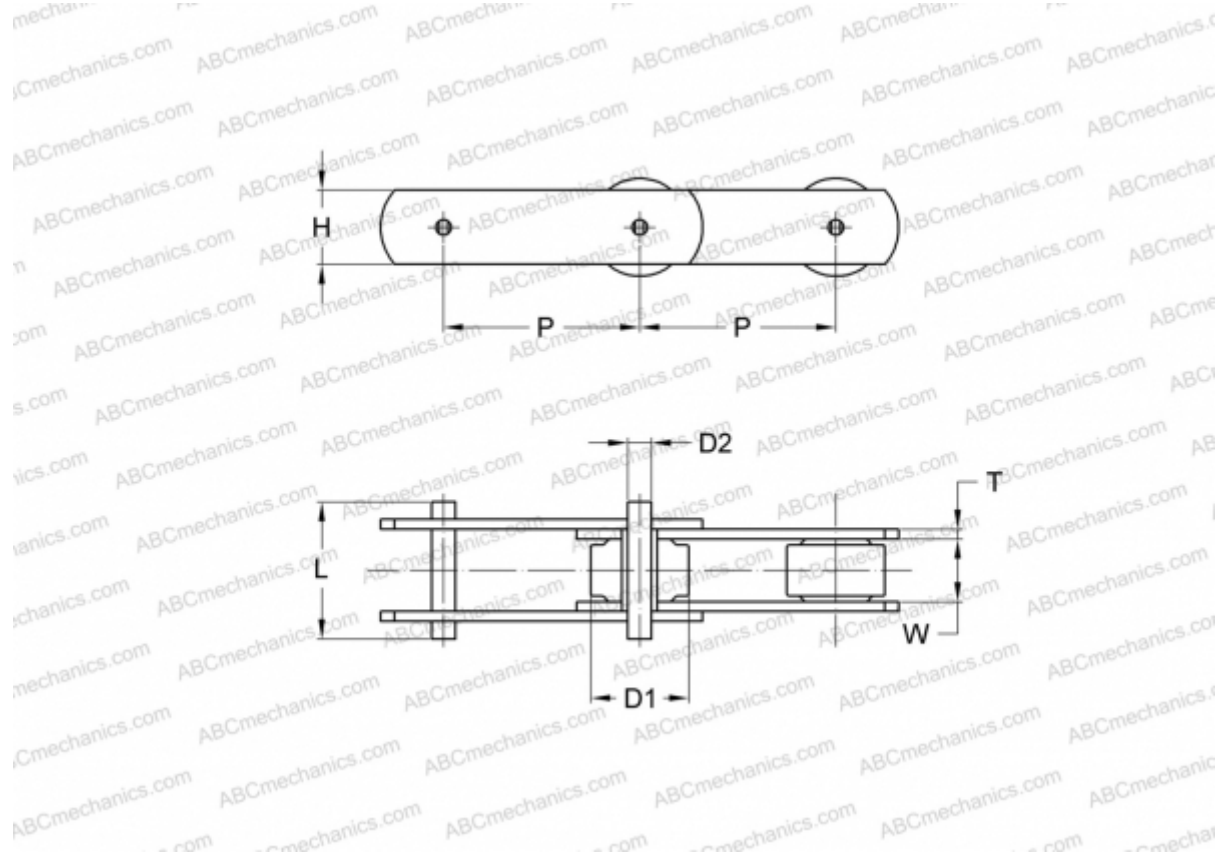

### Technical specification

#### DIMENSIONS, MM

P	500,000
D1	25,000
W	37,000
D2	18,000
H	51,000
T	7,000
L	85,000

**MANUFACTURER** [SKF](#)

**DESIGNATION BS/ISO:** M160P