

PHC M28P63X10FT SKF

Conveyor chain

TYPE: Conveyor chain, Type M, large roller (SKF)

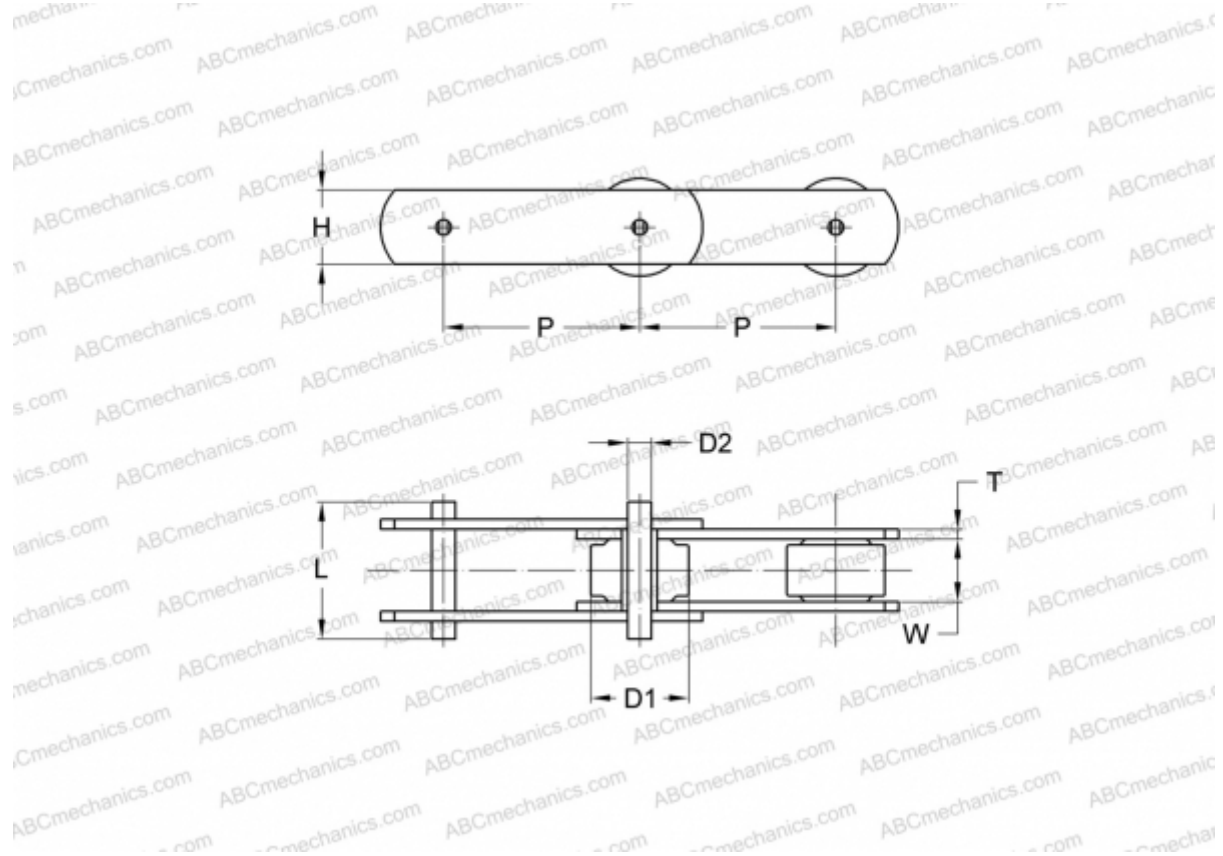

Technical specification

DIMENSIONS, MM

P	63,000
D1	10,000
W	18,000
D2	7,000
H	21,000
T	3,000
L	40,000

MANUFACTURER [SKF](#)

DESIGNATION BS/ISO: M28P