

PHC M224P400X10FT SKF

Conveyor chain

TYPE: Conveyor chain, Type M, large roller (SKF)

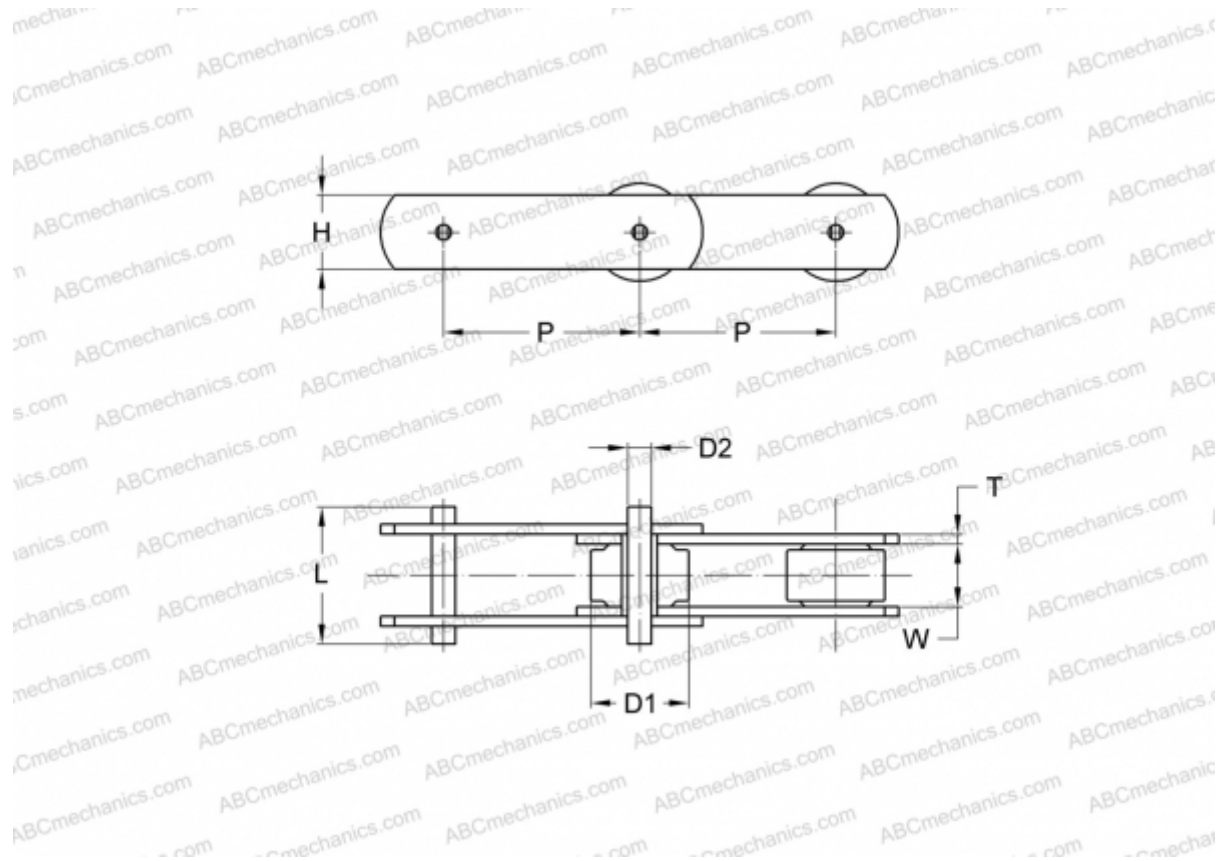

Technical specification

DIMENSIONS, MM

P	400,000
D1	30,000
W	43,000
D2	21,000
H	62,000
T	8,000
L	98,000

MANUFACTURER [SKF](#)

DESIGNATION BS/ISO: M224P