

PHC M315P500X10FT SKF

Conveyor chain

TYPE: Conveyor chain, Type M, large roller (SKF)

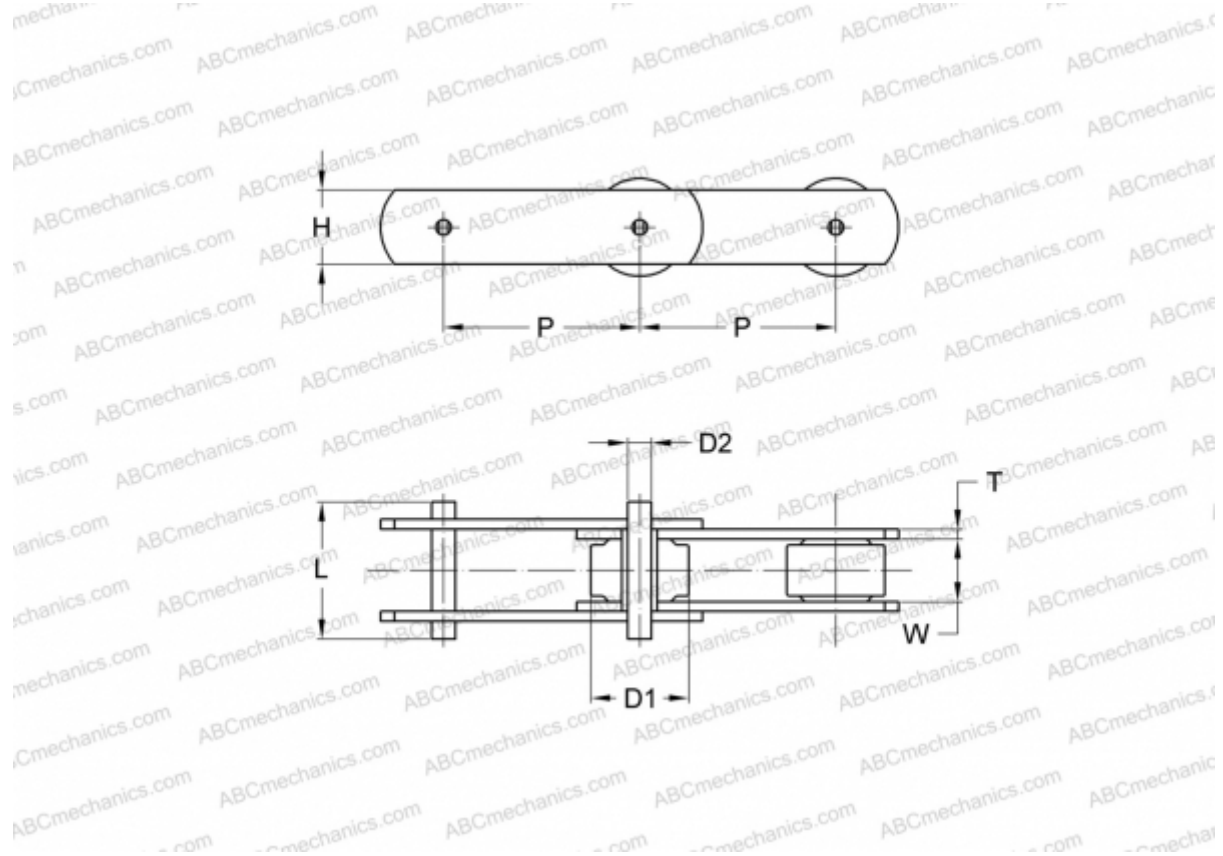

Technical specification

DIMENSIONS, MM

P	500,000
D1	36,000
W	48,000
D2	25,000
H	72,000
T	10,000
L	112,000

MANUFACTURER [SKF](#)

DESIGNATION BS/ISO: M315P