

PHC M28F125X5M SKF

Conveyor chain

TYPE: Conveyor chain, Type M, flanged roller (SKF)

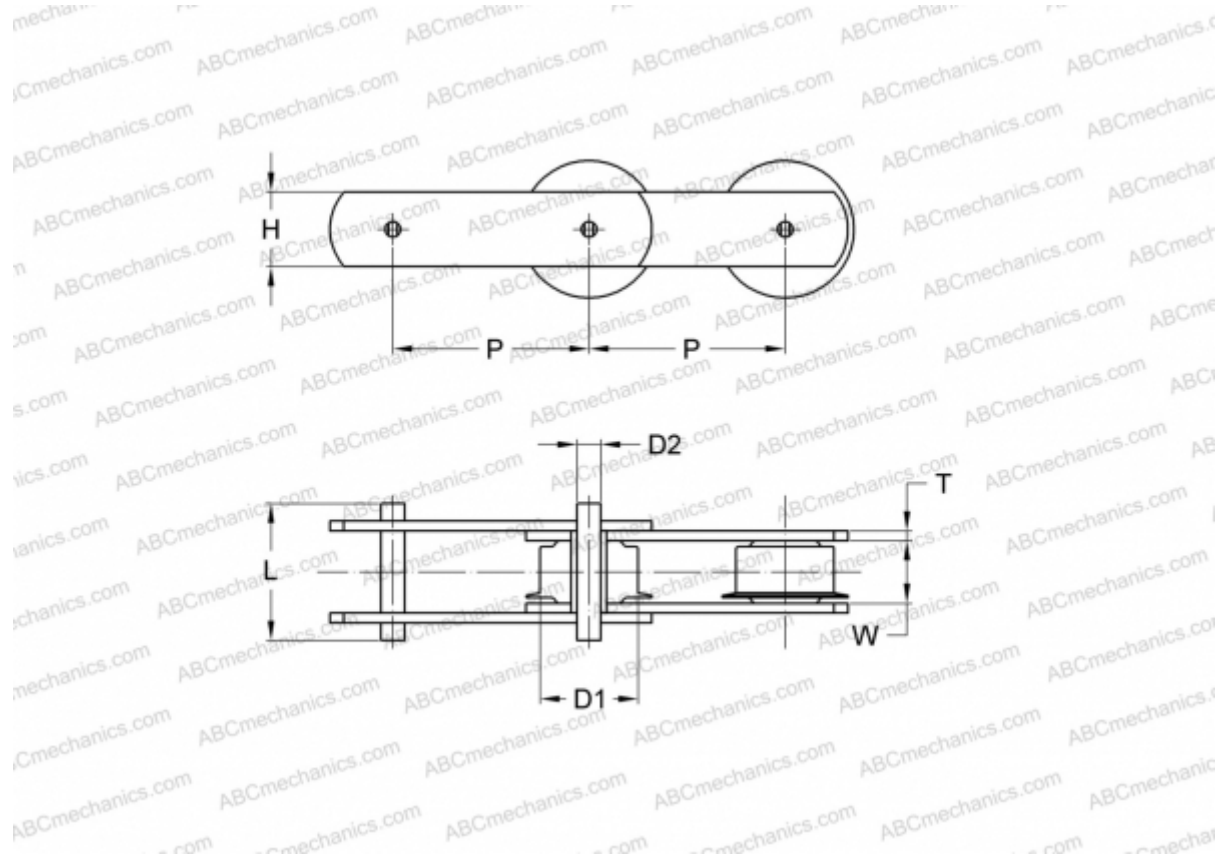

Technical specification

DIMENSIONS, MM

| | |
|----|---------|
| P | 125,000 |
| D1 | 10,000 |
| W | 18,000 |
| D2 | 7,000 |
| H | 21,000 |
| T | 3,000 |
| L | 40,000 |

MANUFACTURER [SKF](#)

DESIGNATION BS/ISO: M28F