

PHC M160F160X5M SKF

Conveyor chain

TYPE: Conveyor chain, Type M, flanged roller (SKF)

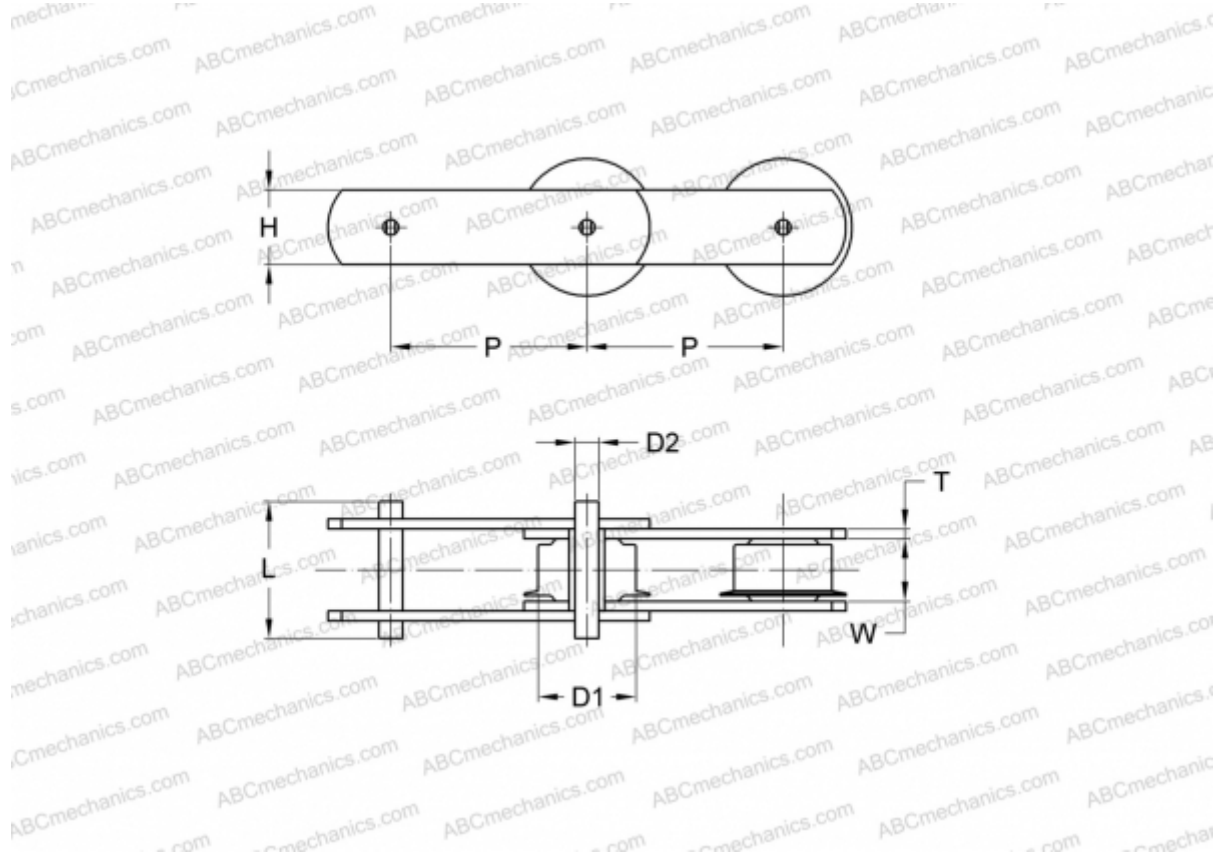

Technical specification

DIMENSIONS, MM

P	160,000
D1	25,000
W	37,000
D2	18,000
H	51,000
T	7,000
L	85,000

MANUFACTURER [SKF](#)

DESIGNATION BS/ISO: M160F