

PHC M224F160X5M SKF

Conveyor chain

TYPE: Conveyor chain, Type M, flanged roller (SKF)

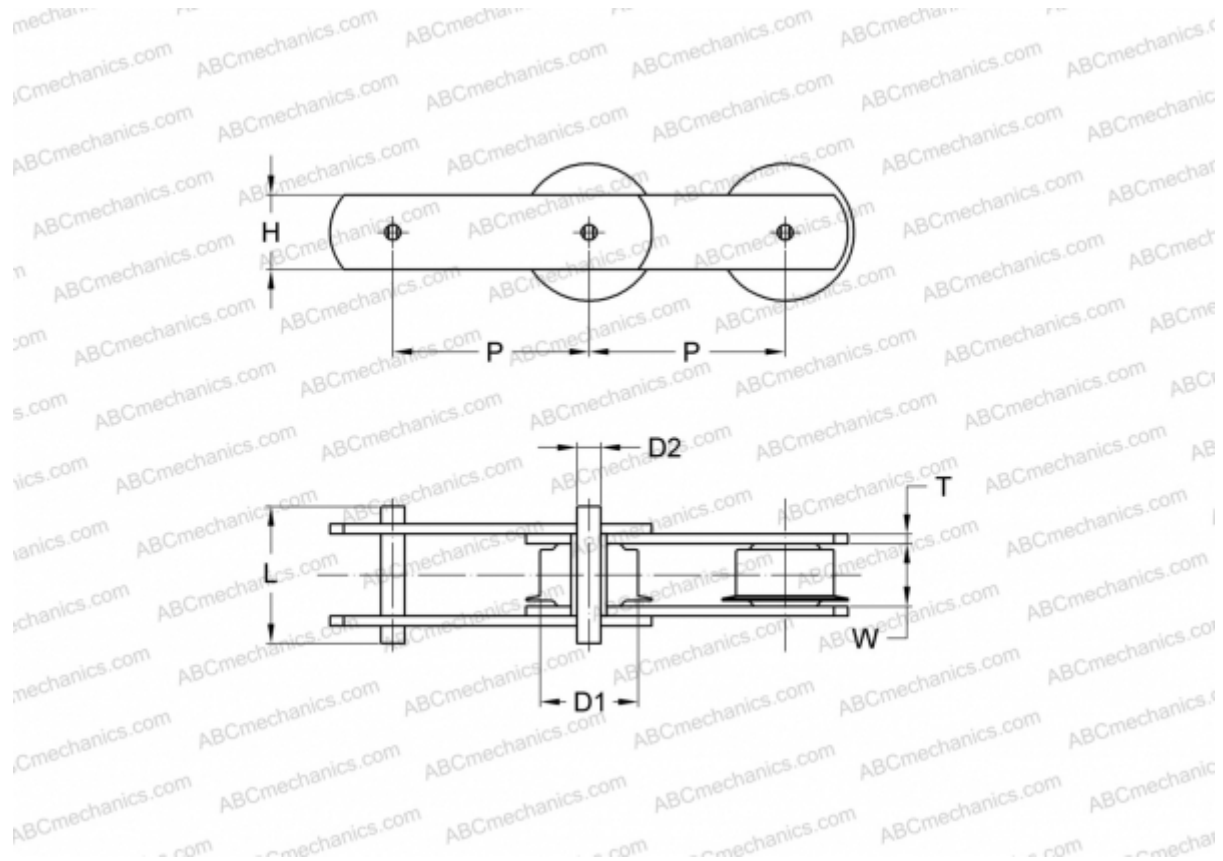

Technical specification

DIMENSIONS, MM

P	160,000
D1	30,000
W	43,000
D2	21,000
H	62,000
T	8,000
L	98,000

MANUFACTURER [SKF](#)

DESIGNATION BS/ISO: M224F