

## PHC M224F400X5M SKF

Conveyor chain

TYPE: Conveyor chain, Type M, flanged roller (SKF)

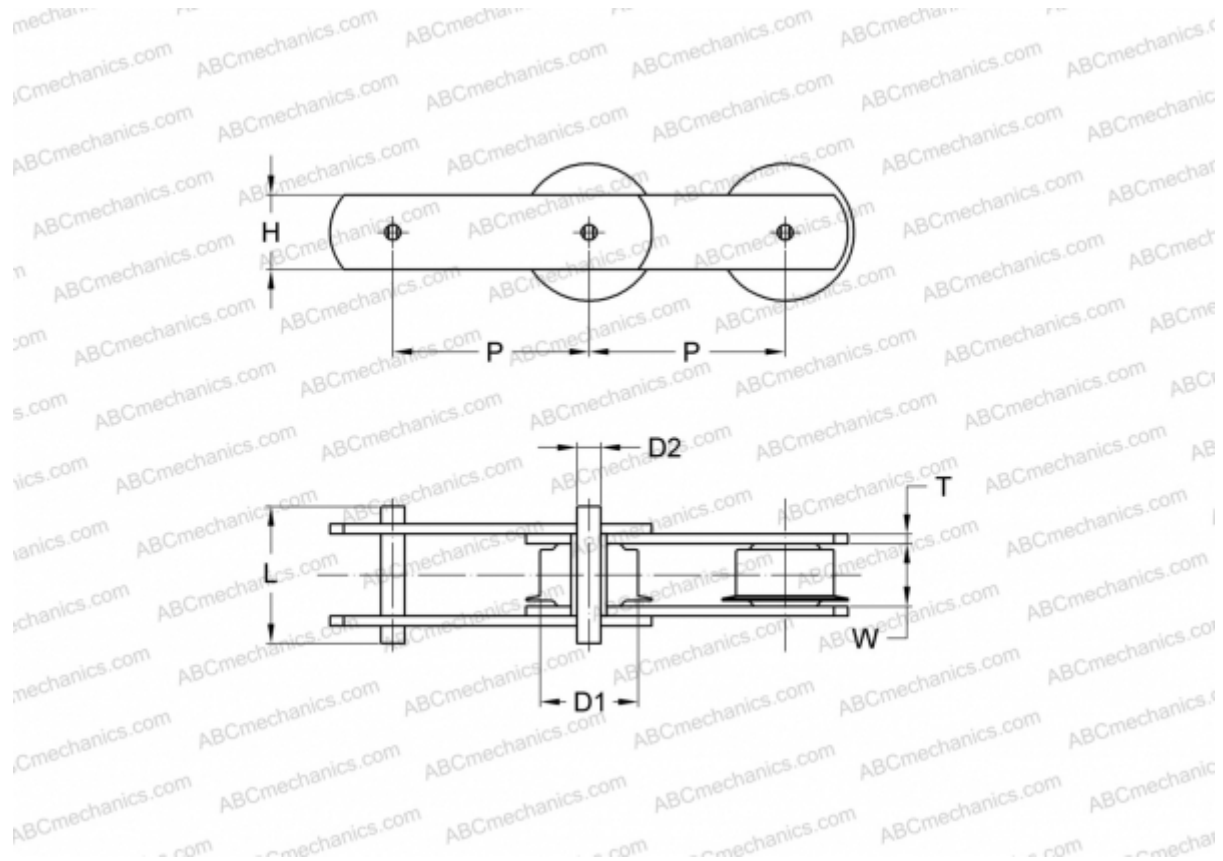

### Technical specification

#### DIMENSIONS, MM

P	400,000
D1	30,000
W	43,000
D2	21,000
H	62,000
T	8,000
L	98,000

**MANUFACTURER** [SKF](#)

**DESIGNATION BS/ISO:** M224F