

PHC M450F250X5M SKF

Conveyor chain

TYPE: Conveyor chain, Type M, flanged roller (SKF)

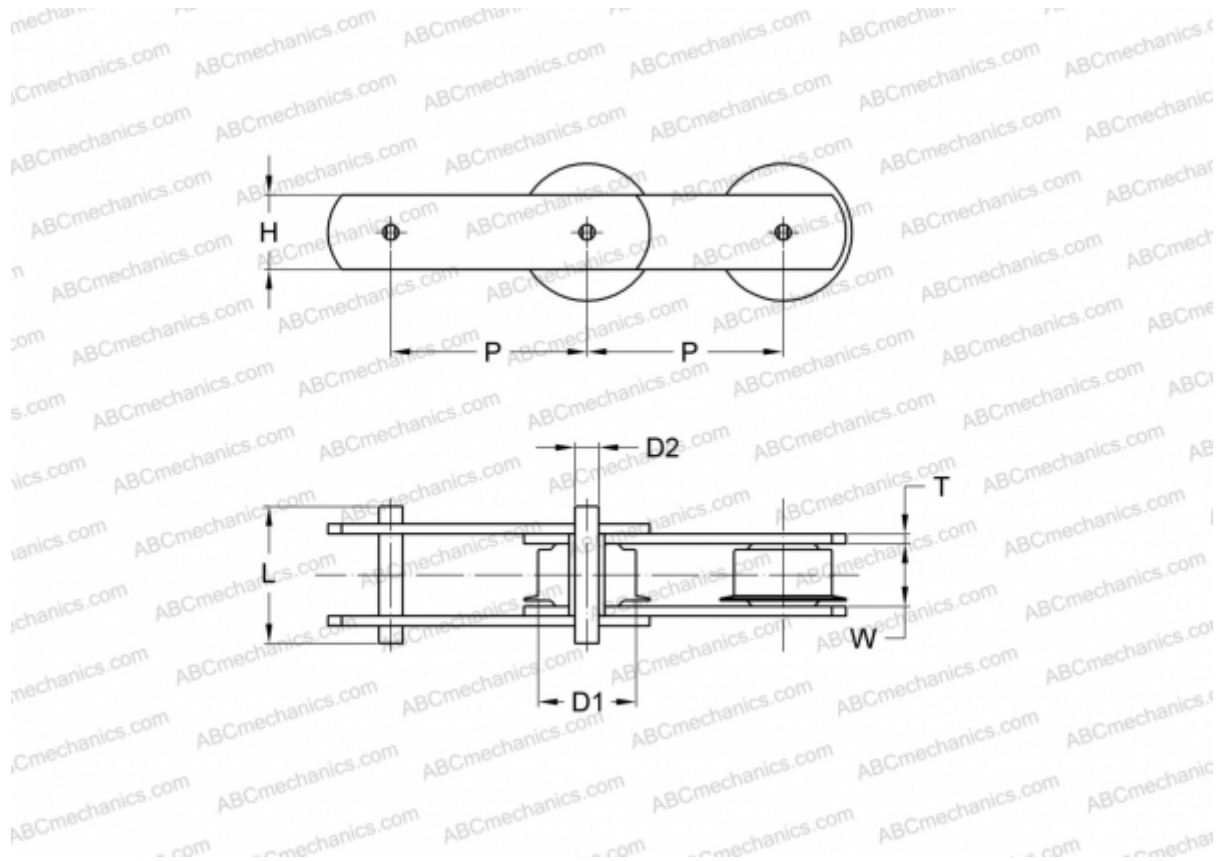

Technical specification

DIMENSIONS, MM

| | |
|----|---------|
| P | 250,000 |
| D1 | 42,000 |
| W | 56,000 |
| D2 | 30,000 |
| H | 82,000 |
| T | 12,000 |
| L | 135,000 |

MANUFACTURER [SKF](#)

DESIGNATION BS/ISO: M450F