

PHC M20F100X10FT SKF

Conveyor chain

TYPE: Conveyor chain, Type M, flanged roller (SKF)

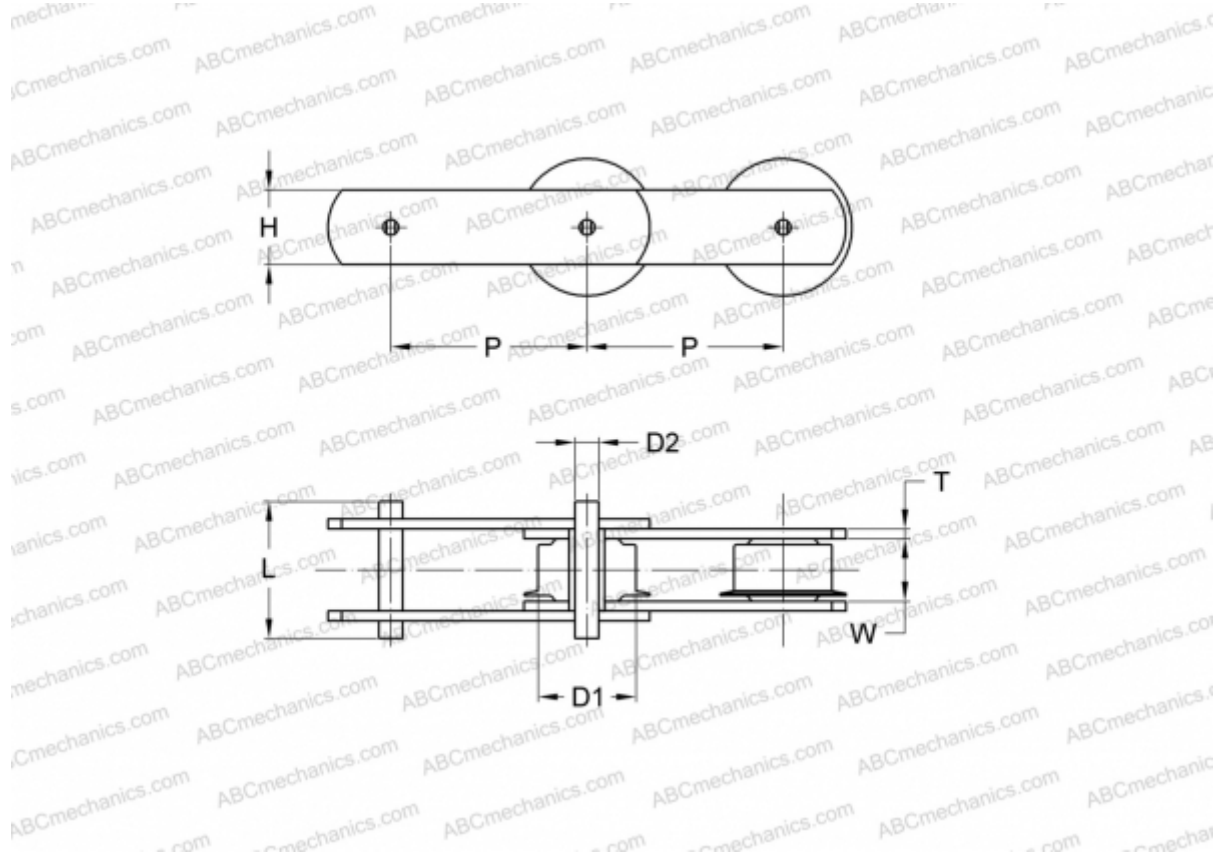

Technical specification

DIMENSIONS, MM

P	100,000
D1	9,000
W	16,000
D2	6,000
H	19,000
T	2,500
L	35,000

MANUFACTURER [SKF](#)

DESIGNATION BS/ISO: M20F