

## PHC 3939-B40X5M SKF

Conveyor chain

TYPE: Conveyor chains for special use, Lumber mill series, Series 3939 (SKF)

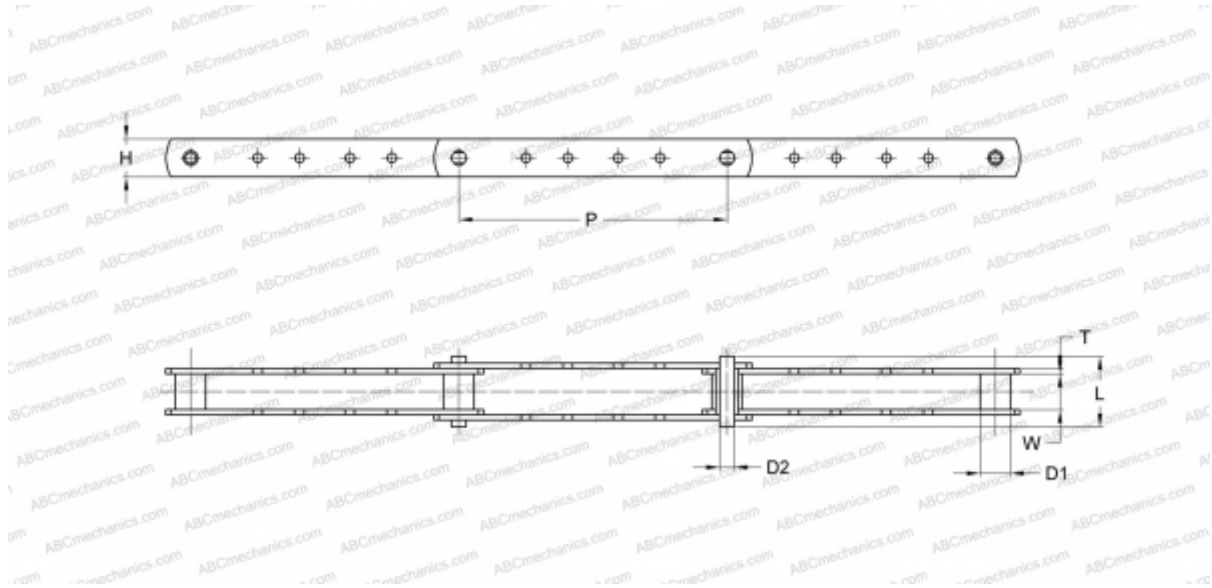

### Technical specification

#### DIMENSIONS, MM

P	203,200
D1	23,000
W	27,000
D2	11,100
H	28,580
T	4,000
L	49,000

**WEIGHT, KG/M** 2,450

**MANUFACTURER** [SKF](#)

**DESIGNATION BS/ISO:** 3939-B40