

PHC 3939-B4X10FT SKF

Conveyor chain

TYPE: Conveyor chains for special use, Lumber mill series, Series 3939 (SKF)

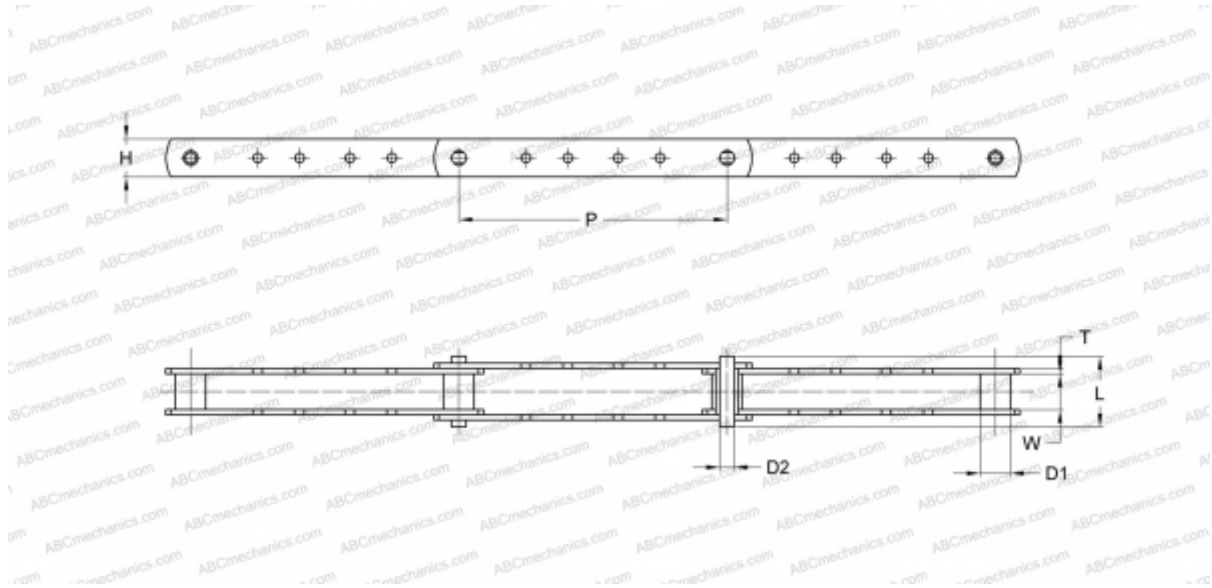

Technical specification

DIMENSIONS, MM

P	203,200
D1	23,000
W	27,000
D2	11,100
H	28,580
T	4,000
L	49,000

WEIGHT, KG/M 2,450

MANUFACTURER [SKF](#)

DESIGNATION BS/ISO: 3939-B4