

PHC CL12-46.0X10FT SKF

Silent Chain

TYPE: Silent chains, With the contact on the side of sprocket's tooth (SKF)

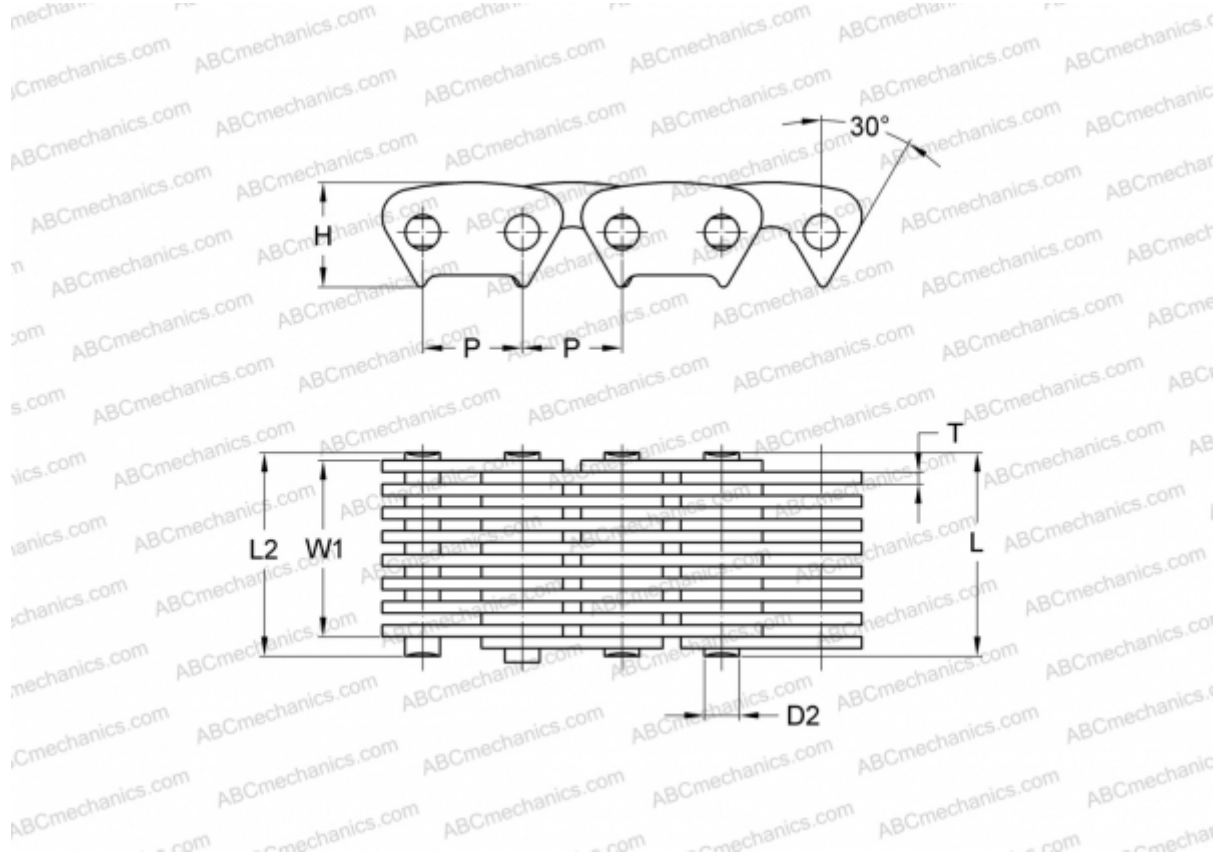

Technical specification

DIMENSIONS, MM

P	19,050
D2	6,900
H	20,000
T	2,000
L	53,000
L2	54,500
W1	46,000

WEIGHT, KG/M 4,080

MANUFACTURER [SKF](#)

DESIGNATION BS/ISO: CL12-46.0