

## PHC CL12-62.0X10FT SKF

Silent Chain

TYPE: Silent chains, With the contact on the side of sprocket's tooth (SKF)

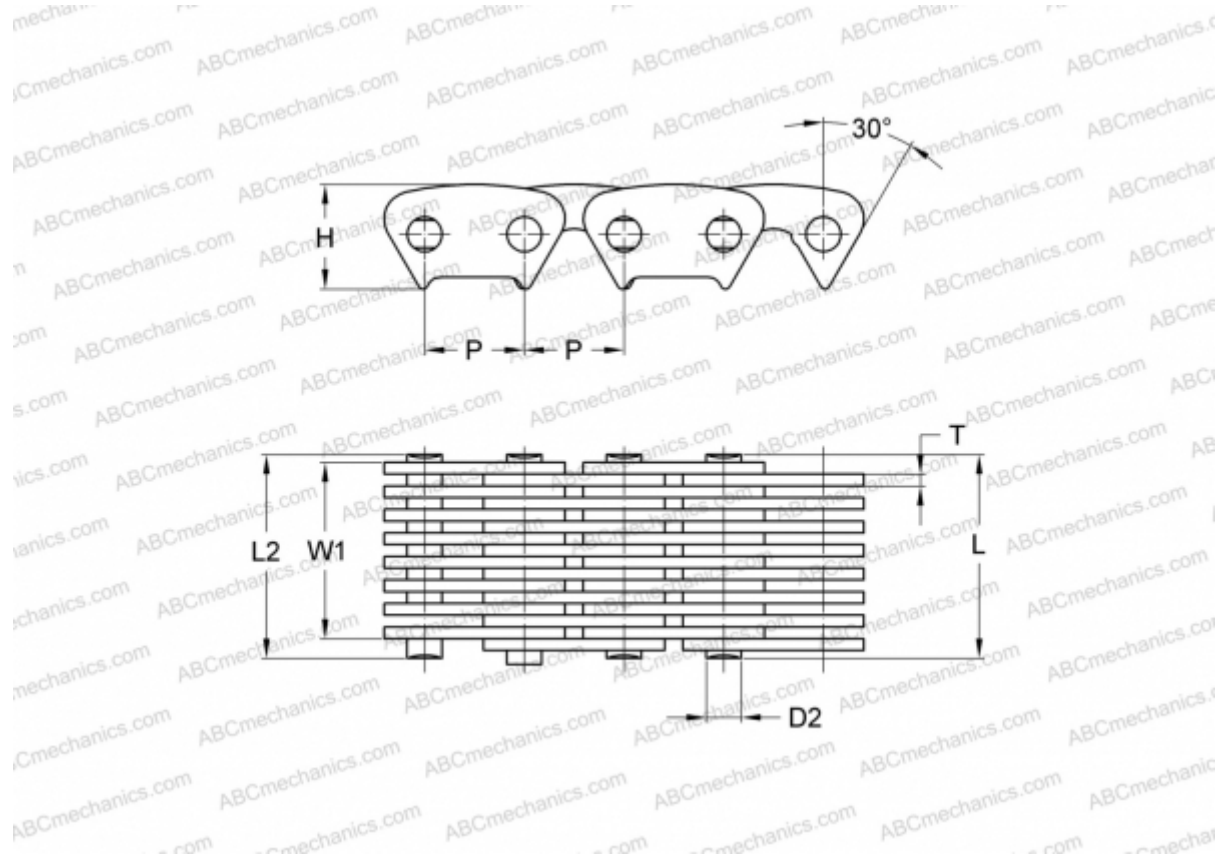

### Technical specification

#### DIMENSIONS, MM

P	19,050
D2	6,900
H	20,000
T	2,000
L	69,000
L2	70,800
W1	62,000

**WEIGHT, KG/M** 5,500

**MANUFACTURER** [SKF](#)

**DESIGNATION BS/ISO:** CL12-62.0