

PHC 2050X5M SKF

Double Pitch Roller Chain

TYPE: Drive roller chain, Double pitch chain conveyor series, SKF

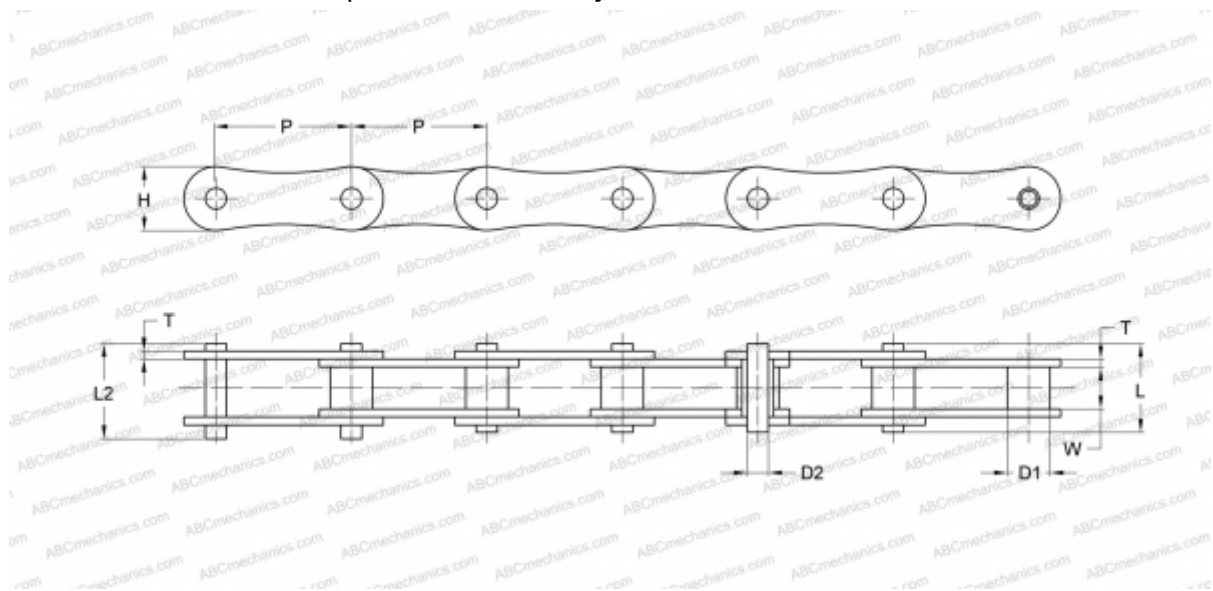

Technical specification

DIMENSIONS, MM

P	31,750
D1	10,160
W	9,400
D2	5,080
H	15,000
T	2,030
L	16,600
L2	17,800

WEIGHT, KG/M 0,730

MANUFACTURER [SKF](#)

DESIGNATION BS/ISO: 210A

DESIGNATION ANSI: 2050