

## PHC 2100X10FT SKF

Double Pitch Roller Chain

TYPE: Drive roller chain, Double pitch chain conveyor series, SKF

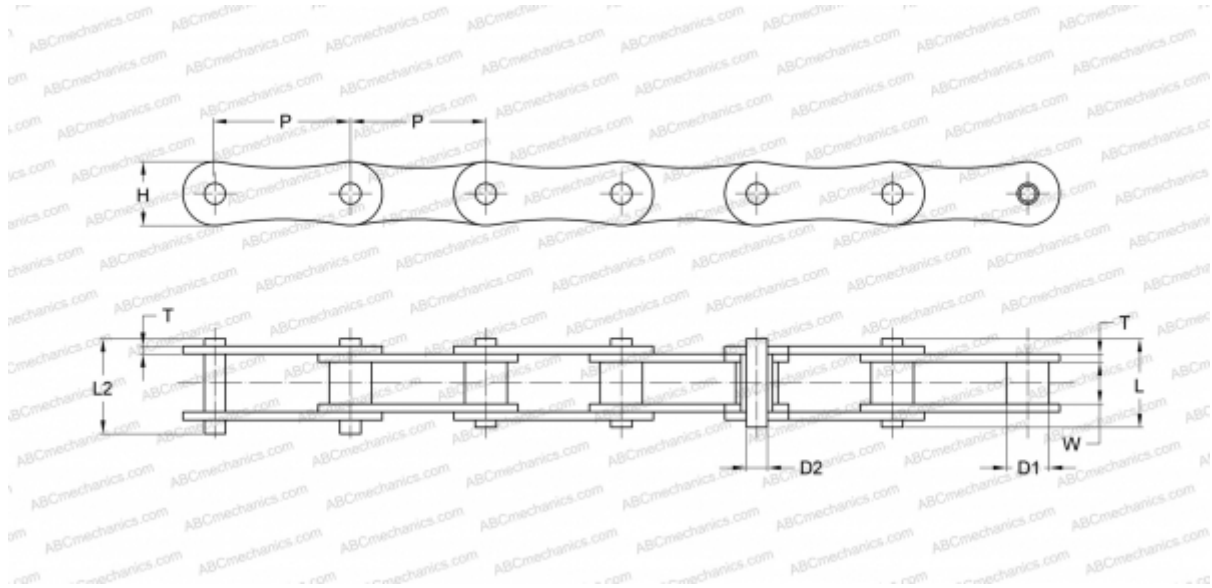

### Technical specification

#### DIMENSIONS, MM

P	63,500
D1	19,050
W	18,900
D2	9,530
H	30,000
T	4,000
L	16,600
L2	17,800

**WEIGHT, KG/M** 2,550

**MANUFACTURER** [SKF](#)

**DESIGNATION BS/ISO:** 220A

**DESIGNATION ANSI:** 2100