

PHC 210BX10FT SKF

Double Pitch Roller Chain

TYPE: Drive roller chain, Double pitch chain conveyor series, SKF

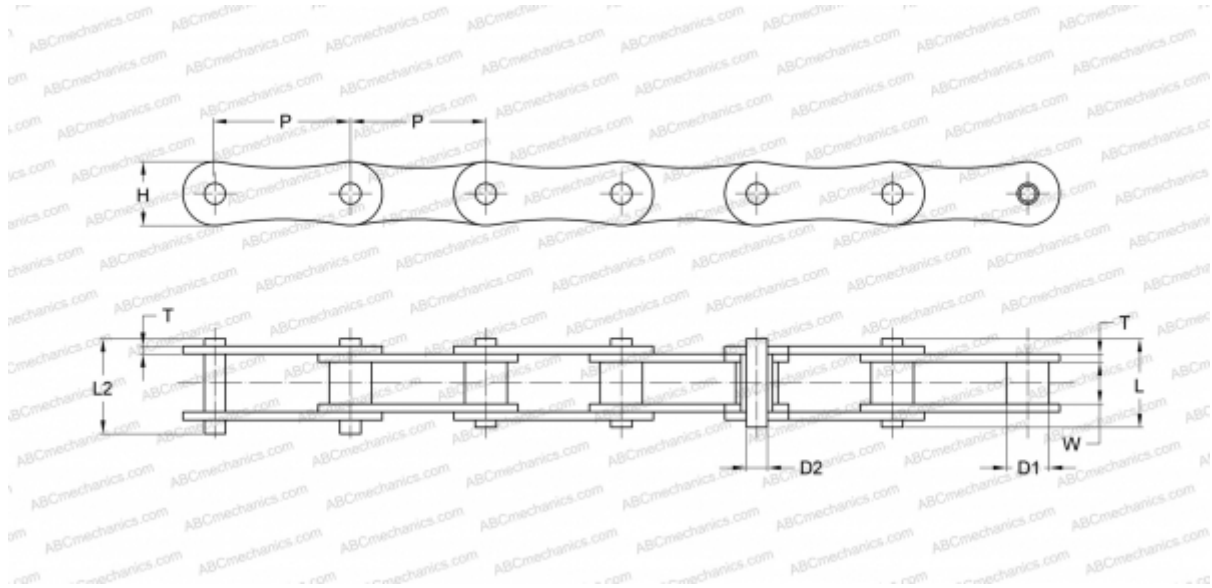

Technical specification

DIMENSIONS, MM

P	31,750
D1	10,160
W	9,650
D2	5,080
H	14,700
T	1,700
L	16,600
L2	17,800

WEIGHT, KG/M 0,650

MANUFACTURER [SKF](#)

DESIGNATION BS/ISO: 210B