

PHC 216BX10FT SKF

Double Pitch Roller Chain

TYPE: Drive roller chain, Double pitch chain conveyor series, SKF

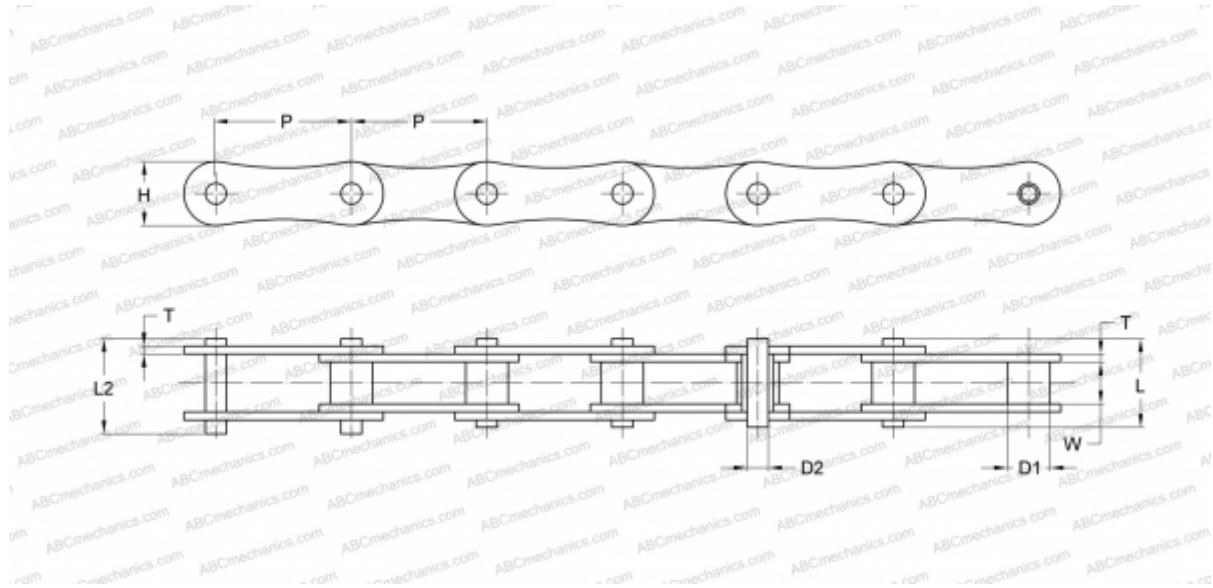

Technical specification

DIMENSIONS, MM

P	50,800
D1	15,880
W	17,020
D2	8,280
H	21,000
T	3,100
L	16,600
L2	17,800

WEIGHT, KG/M 1,750

MANUFACTURER [SKF](#)

DESIGNATION BS/ISO: 216B