

SM 5 NB

Linear bushing

TYPE: Shaft guidance systems, Linear bushing, Standard, Close type, Type SM, Asian standard, Steel cage (NB)

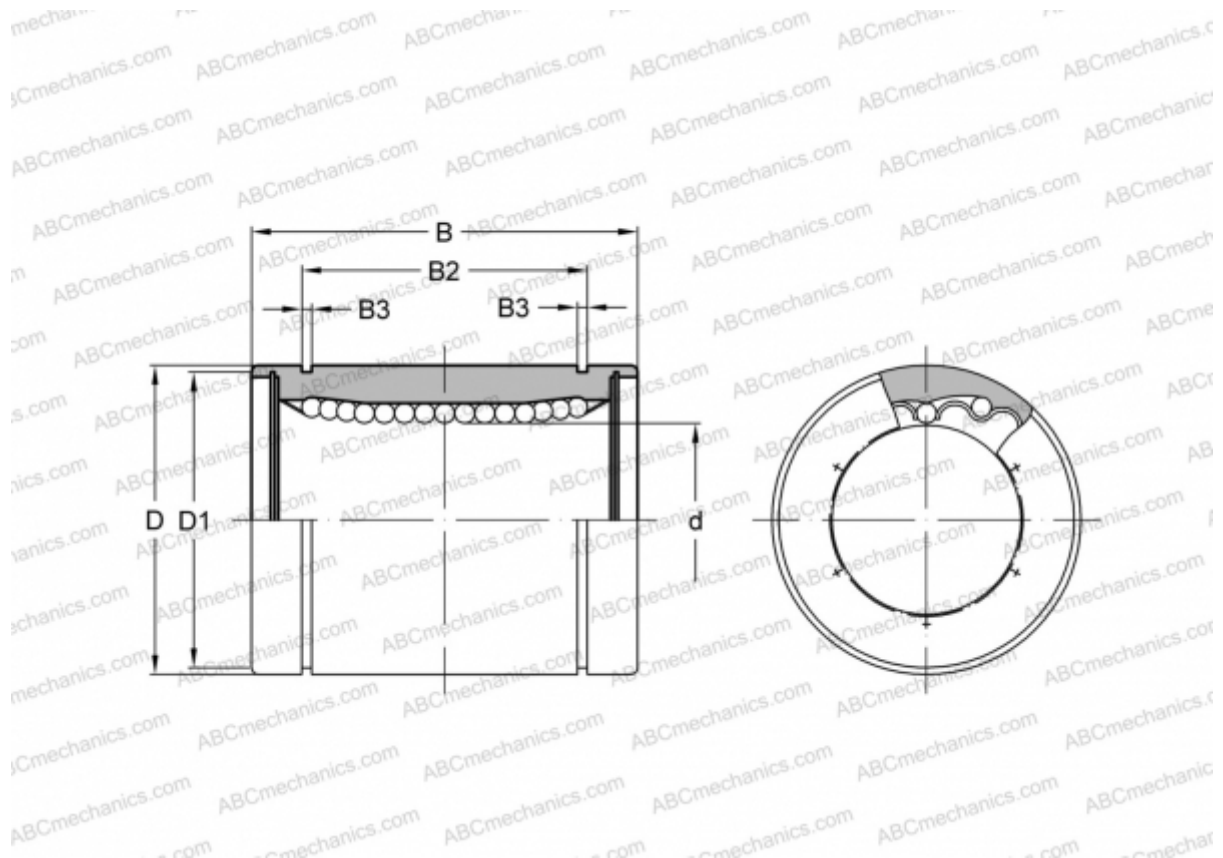

Technical specification

DIMENSIONS, MM

d	5,000
D	10,000
B	15,000
D1	9,600
B2	10,200
B3	1,100

WEIGHT, KG 0,004

MANUFACTURER [NB](#)