

0600-012-00 STAR

Linear bushing

TYPE: Shaft guidance systems, Linear bushing, Standard, Close type, Type LBE

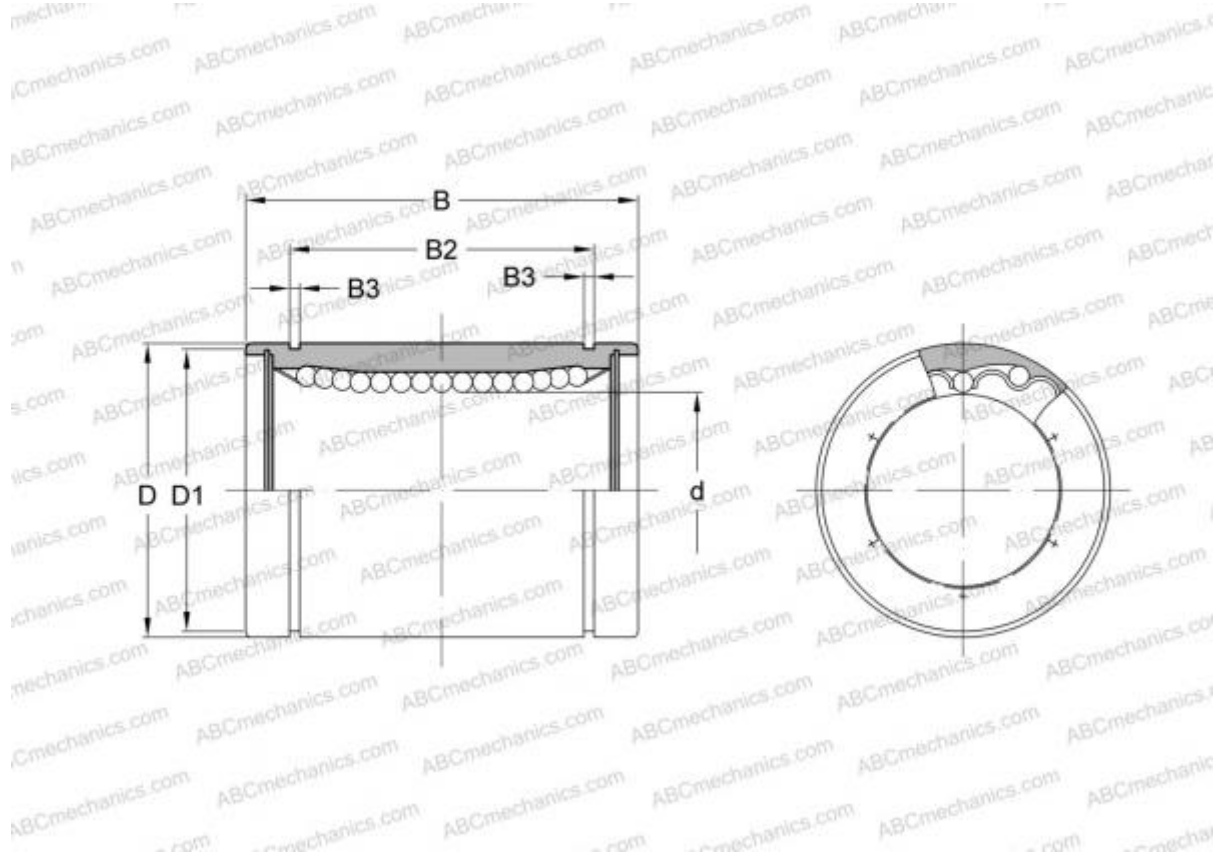

Technical specification

DIMENSIONS, MM

d	12,000
D	22,000
B	32,000

MANUFACTURER [STAR](#)

INTERCHANGE

ABC	LBE 12
IKO	LBE 12
THOMSON	0600-012-00
INA	KB 1232
SKF	LBCR 12
FAG	LAA 12x22x32