

KB 1636 INA

Linear bushing

TYPE: Shaft guidance systems, Linear bushing, Standard, Close type, Type LBE

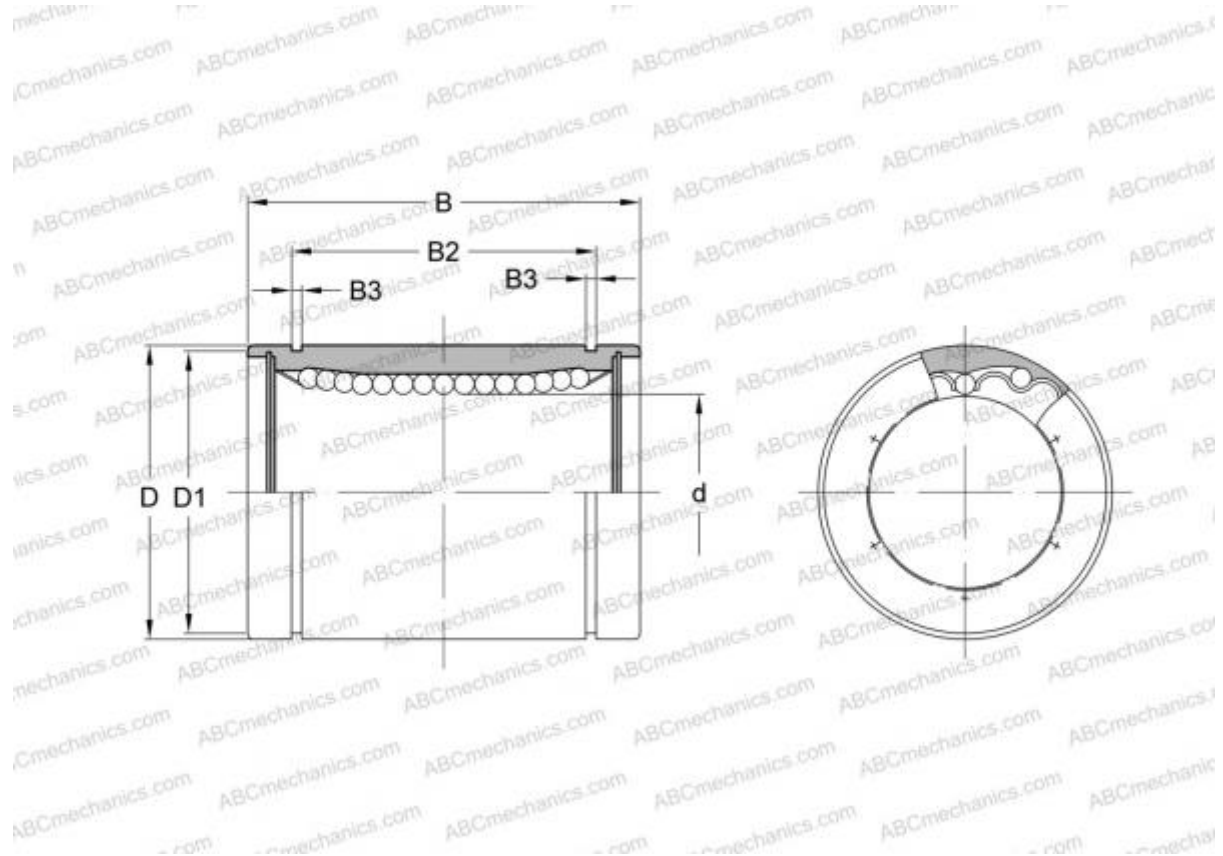

Technical specification

DIMENSIONS, MM

d	16,000
D	26,000
B	36,000

MANUFACTURER [INA](#)

INTERCHANGE

ABC	LBE 16
IKO	LBE 16
STAR	0600-016-00
THOMSON	0600-016-00
SKF	LBCR 16
FAG	LAA 16x26x36