

LBE 25 IKO

Linear bushing

TYPE: Shaft guidance systems, Linear bushing, Standard, Close type, Type LBE

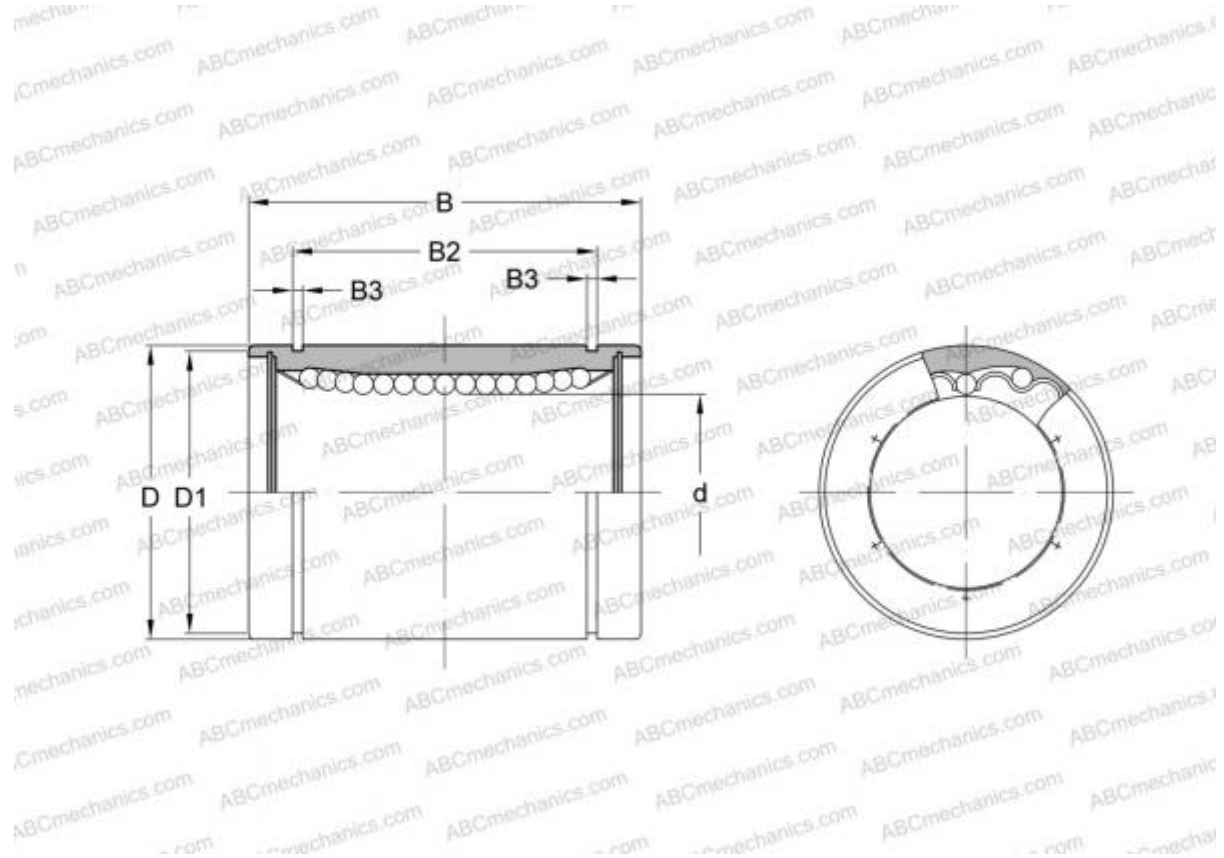

Technical specification

DIMENSIONS, MM

d	25,000
D	40,000
B	58,000

WEIGHT, KG 0,161

MANUFACTURER [IKO](#)

INTERCHANGE

ABC	LBE 25
STAR	0600-025-00
THOMSON	0600-025-00
INA	KB 2558
SKF	LBCR 25
FAG	LAA 25x40x58

CALCULATION DATA

Basic dynamic load rating min	1,070 kN
Basic dynamic load rating max	1,270 kN
Basic static load rating min	2,020 kN
Basic static load rating max	2,960 kN