

0600-025-00 STAR

Linear bushing

TYPE: Shaft guidance systems, Linear bushing, Standard, Close type, Type LBE

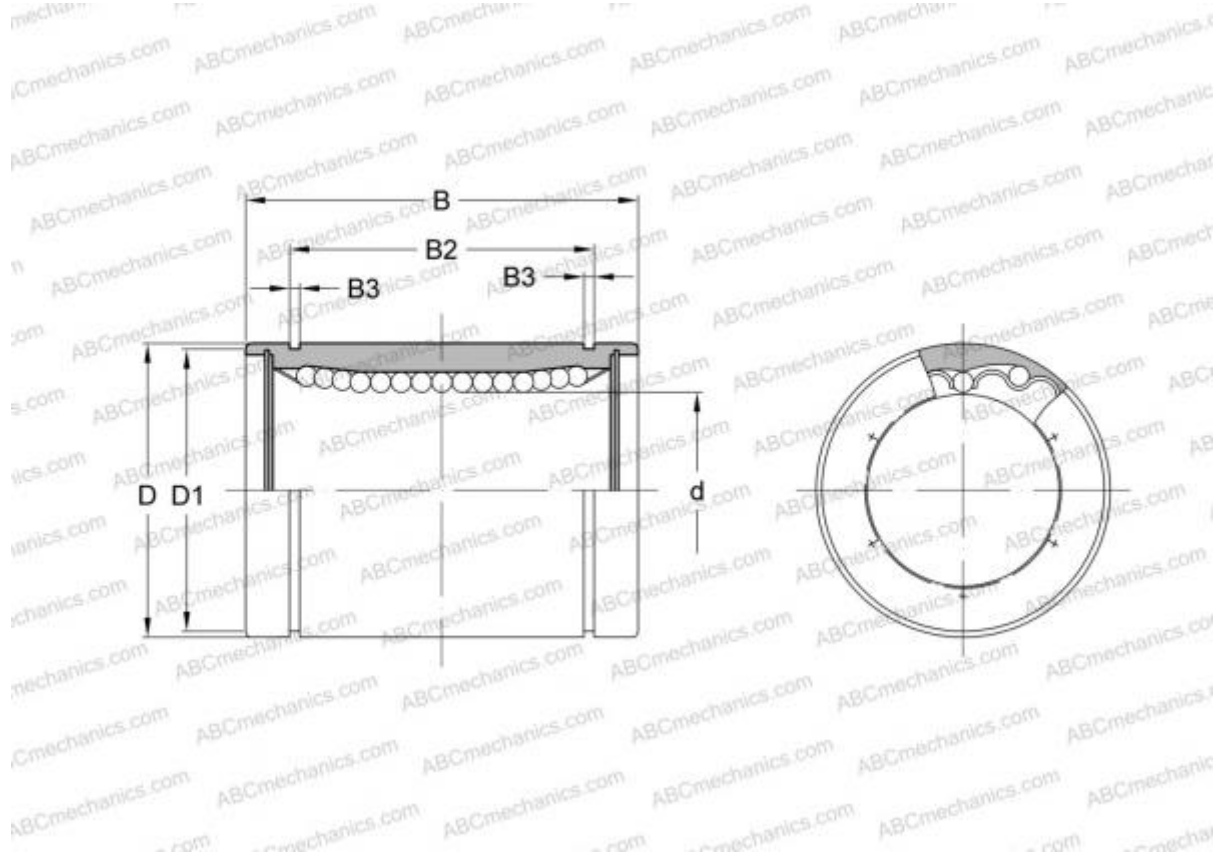

Technical specification

DIMENSIONS, MM

d	25,000
D	40,000
B	58,000

MANUFACTURER [STAR](#)

INTERCHANGE

ABC	LBE 25
IKO	LBE 25
THOMSON	0600-025-00
INA	KB 2558
SKF	LBCR 25
FAG	LAA 25x40x58