

LBE 40 IKO

Linear bushing

TYPE: Shaft guidance systems, Linear bushing, Standard, Close type, Type LBE

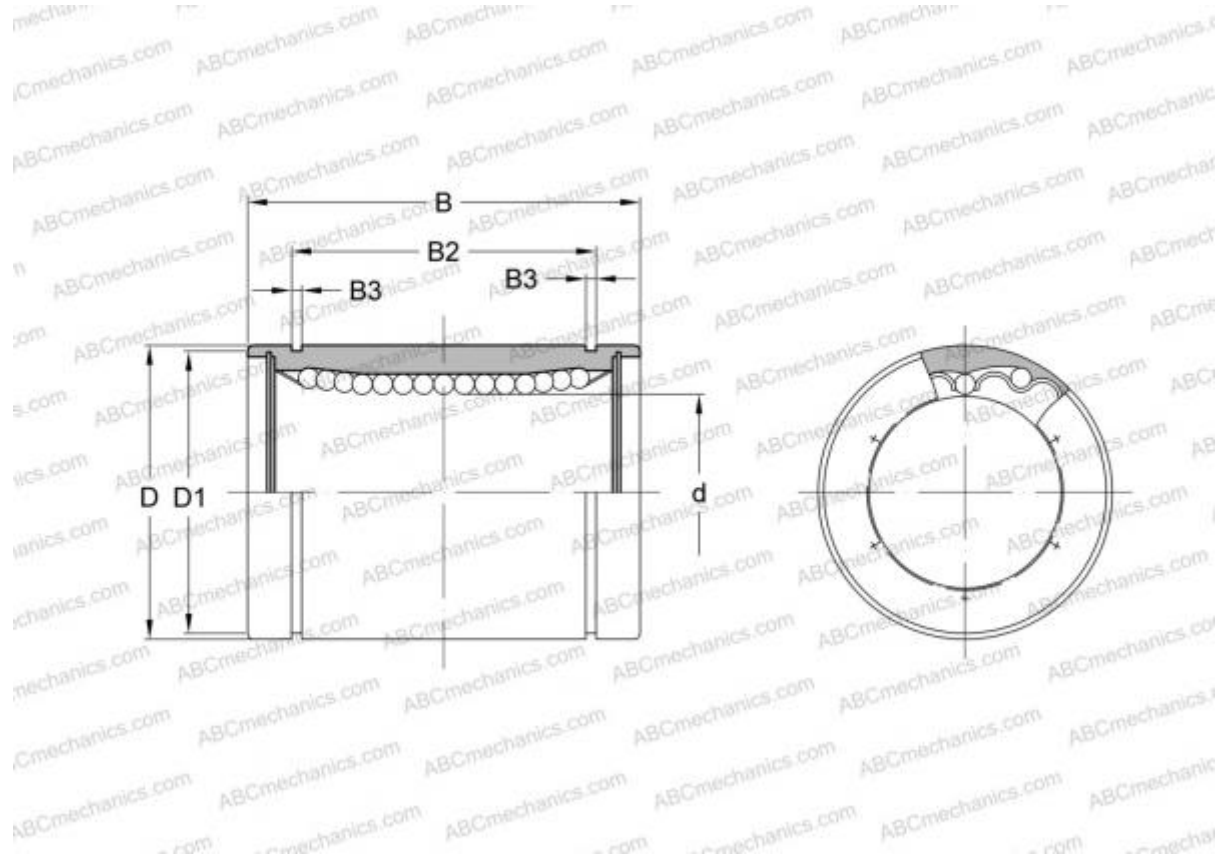

Technical specification

DIMENSIONS, MM

d	40,000
D	62,000
B	80,000

WEIGHT 0,555

MANUFACTURER [IKO](#)

INTERCHANGE

ABC	LBE 40
STAR	0600-040-00
THOMSON	0600-040-00
INA	KB 4080
SKF	LBCR 40
FAG	LAA 40x62x80

CALCULATION DATA

Basic dynamic load rating min	2,710 kN
Basic dynamic load rating max	2,870 kN
Basic static load rating min	4,890 kN
Basic static load rating max	6,250 kN