

SM 8G NB

Linear bushing

TYPE: Shaft guidance systems, Linear bushing, Standard, Close type, Type SM, Asian standard, Plastic cage (NB)

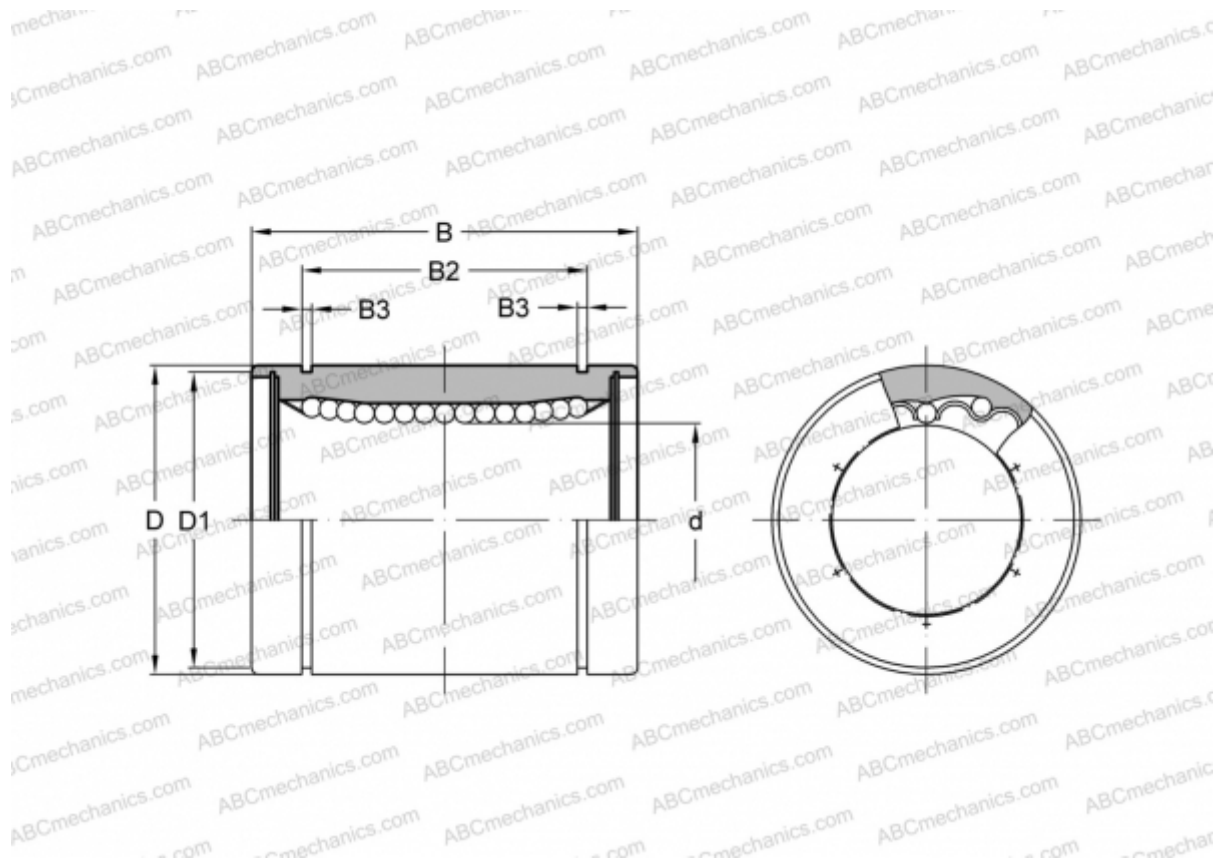

Technical specification

DIMENSIONS, MM

d	8,000
D	15,000
B	24,000
D1	14,300
B2	17,500
B3	1,100

WEIGHT, KG 0,017

MANUFACTURER [NB](#)