

LBE 20 OP IKO

Linear bushing

TYPE: Shaft guidance systems, Linear bushing, Standard, Open type for support rail, Type LBE..OP

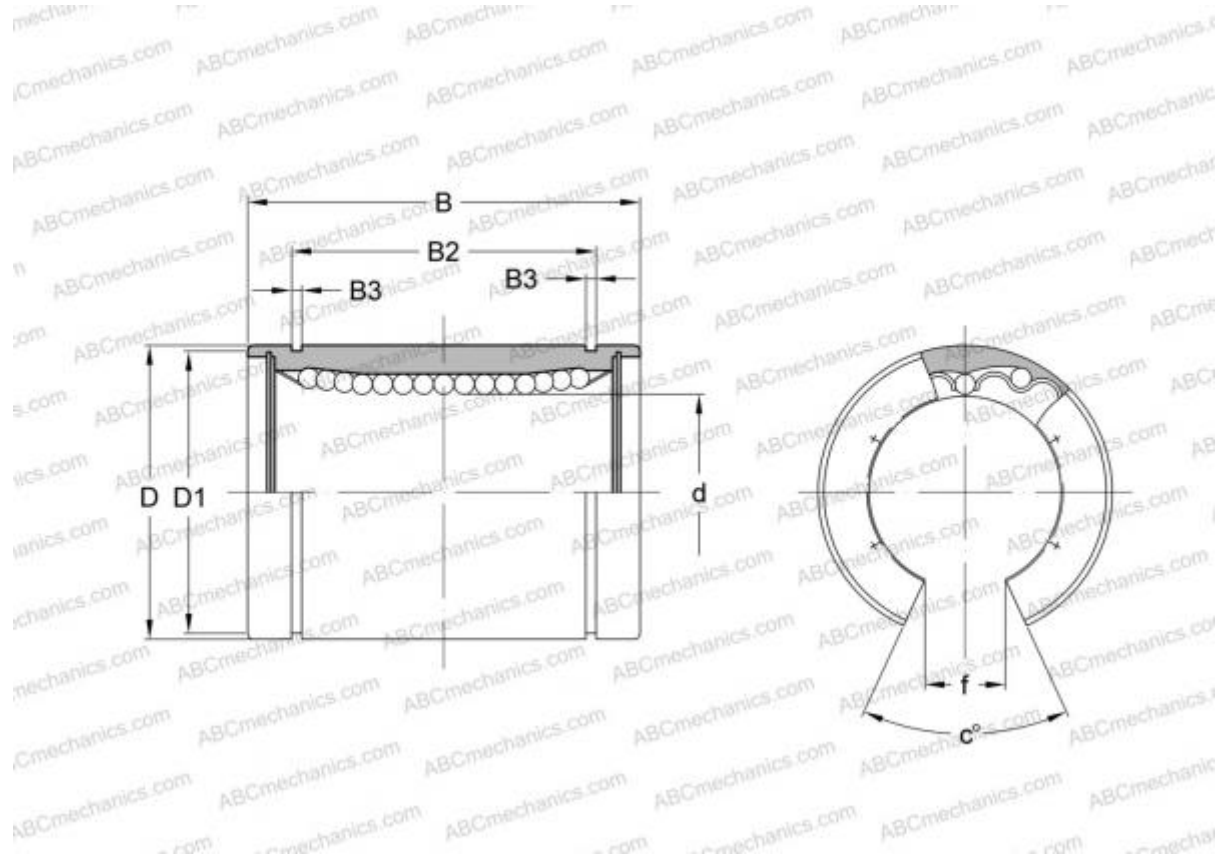

Technical specification

DIMENSIONS, MM

d	20,000
D	32,000
B	45,000
f	10,000
c	60,000

WEIGHT, KG 0,072

MANUFACTURER [IKO](#)

INTERCHANGE

ABC	LBE 20 OP
STAR	0630-020-00
THOMSON	0630-020-00
INA	KBO 2045
SKF	LBCT 20

INTERCHANGE

FAG [LAN 20x32x45](#)

CALCULATION DATA

Basic dynamic load rating min	0,617 kN
Basic dynamic load rating max	0,734 kN
Basic static load rating min	1,150 kN
Basic static load rating max	1,680 kN