

LBE 30 OP IKO

Linear bushing

TYPE: Shaft guidance systems, Linear bushing, Standard, Open type for support rail, Type LBE..OP

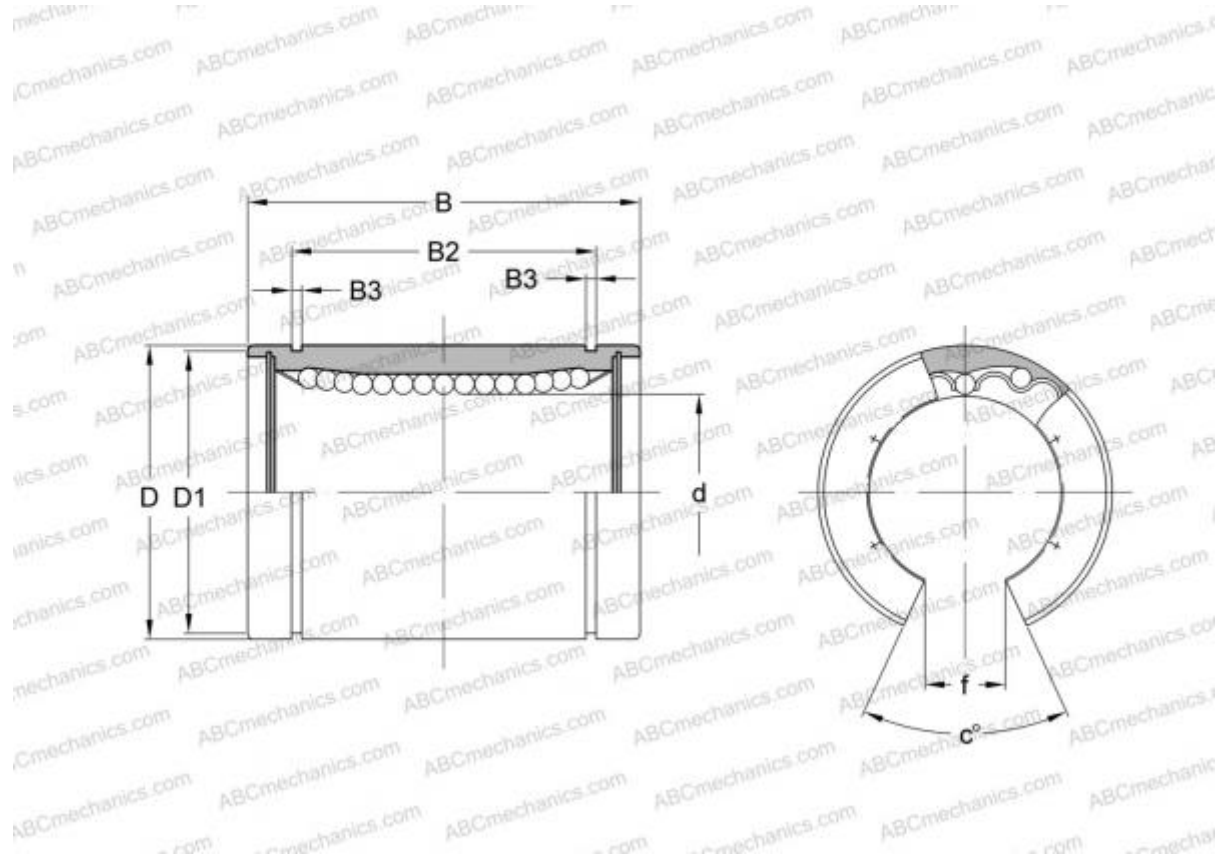

Technical specification

DIMENSIONS, MM

d	30,000
D	47,000
B	68,000
f	12,500
c	50,000

WEIGHT, KG 0,265

MANUFACTURER [IKO](#)

INTERCHANGE

ABC	LBE 30 OP
STAR	0630-030-00
THOMSON	0630-030-00
INA	KBO 3068
SKF	LBCT 30

INTERCHANGE

FAG [LAN 30x47x68](#)

CALCULATION DATA

Basic dynamic load rating min	1,560 kN
Basic dynamic load rating max	1,650 kN
Basic static load rating min	3,060 kN
Basic static load rating max	3,910 kN