

0630-030-00 THOMSON

Linear bushing

TYPE: Shaft guidance systems, Linear bushing, Standard, Open type for support rail, Type LBE..OP

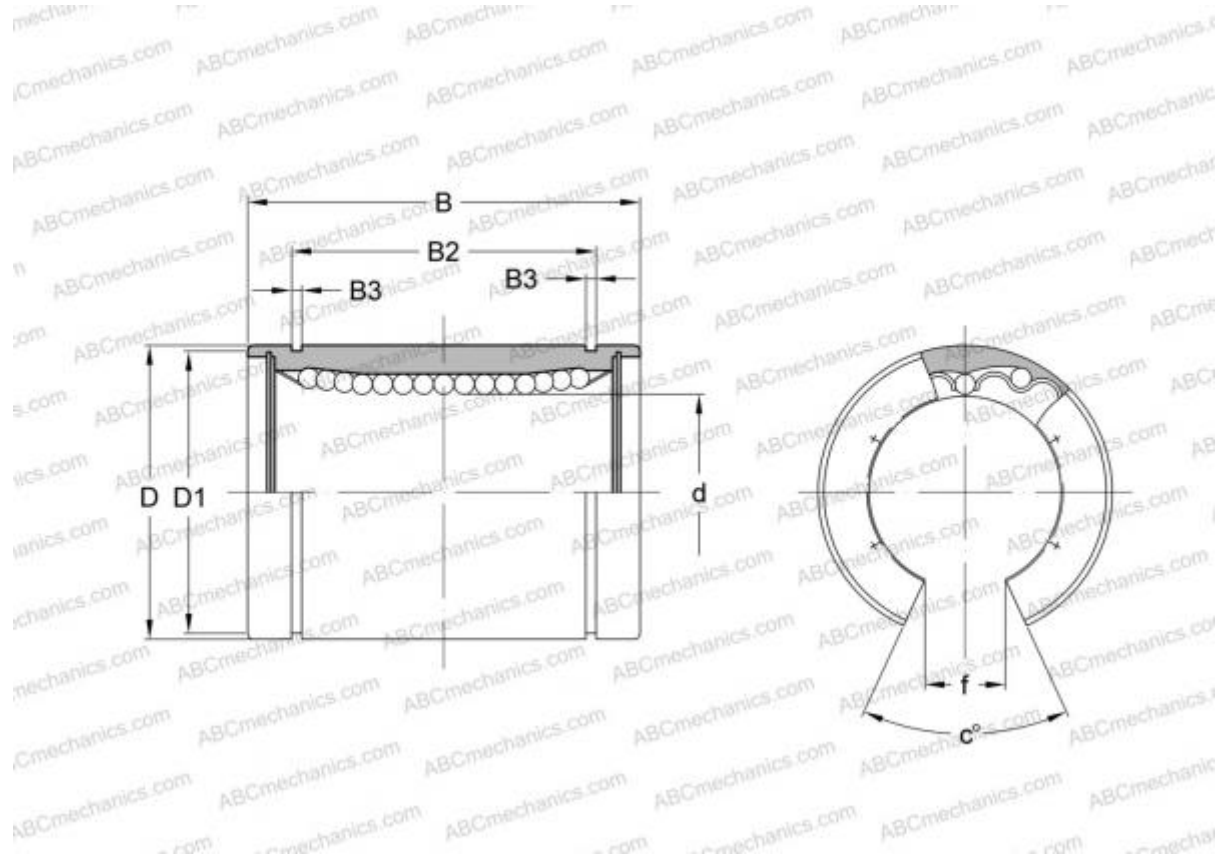

Technical specification

DIMENSIONS, MM

d	30,000
D	47,000
B	68,000
f	12,500
c	50,000

WEIGHT, KG 0,265

MANUFACTURER [THOMSON](#)

INTERCHANGE

ABC	LBE 30 OP
IKO	LBE 30 OP
STAR	0630-030-00
INA	KBO 3068
SKF	LBCT 30

INTERCHANGE

FAG [LAN 30x47x68](#)