

LBE 16 UU ABC

Linear bushing

TYPE: Shaft guidance systems, Linear bushing, Standard, Close type, Type LBE..UU, KB..PP, LBCR..2LS, sealed on both sides

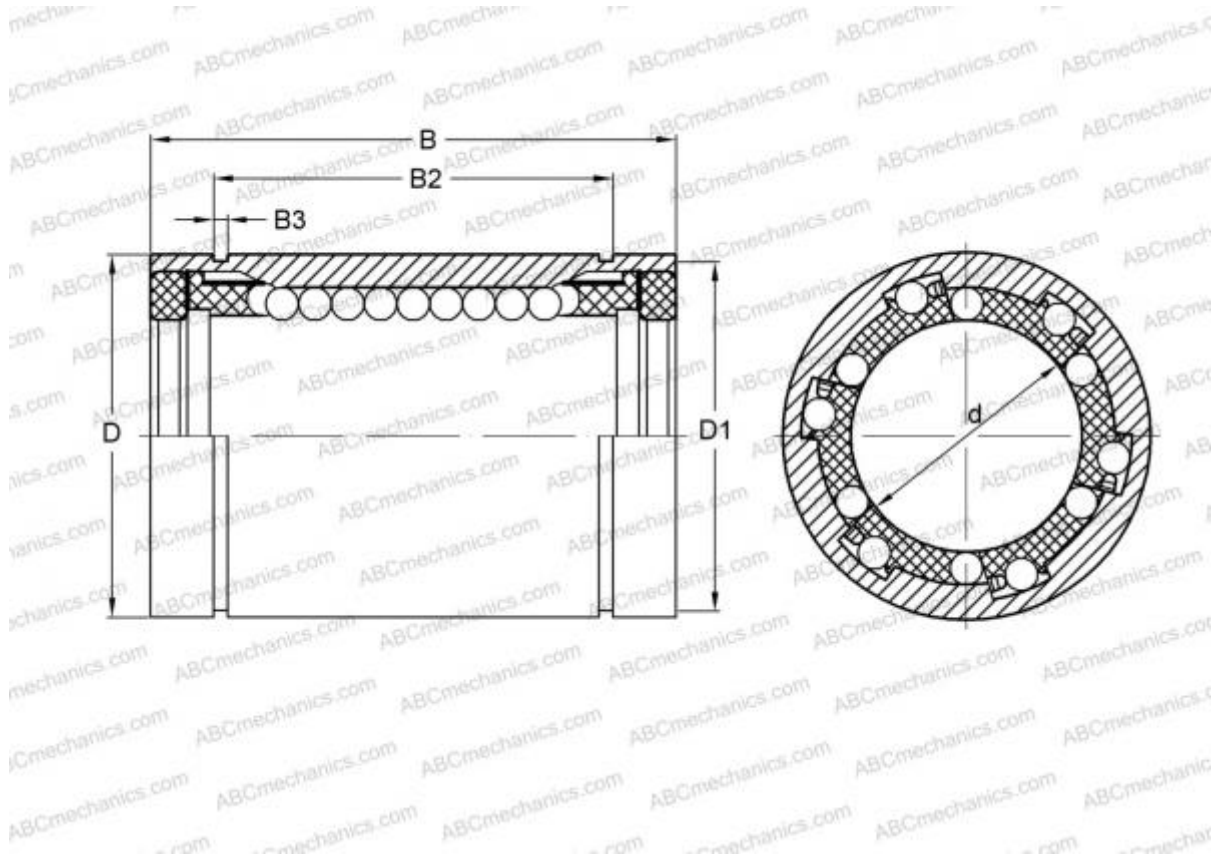

Technical specification

DIMENSIONS, MM

d	16,000
D	26,000
B	36,000

WEIGHT, KG 0,048

MANUFACTURER [ABC](#)

INTERCHANGE

IKO	LBE 16 UU
STAR	0602-016-10
THOMSON	0602-016-10
INA	KB16-PP
SKF	LBCR 16-2LS
FAG	LAA 16x26x36.2RS