

KB16-PP INA

Linear bushing

TYPE: Shaft guidance systems, Linear bushing, Standard, Close type, Type LBE..UU, KB..PP, LBCR..2LS, sealed on both sides

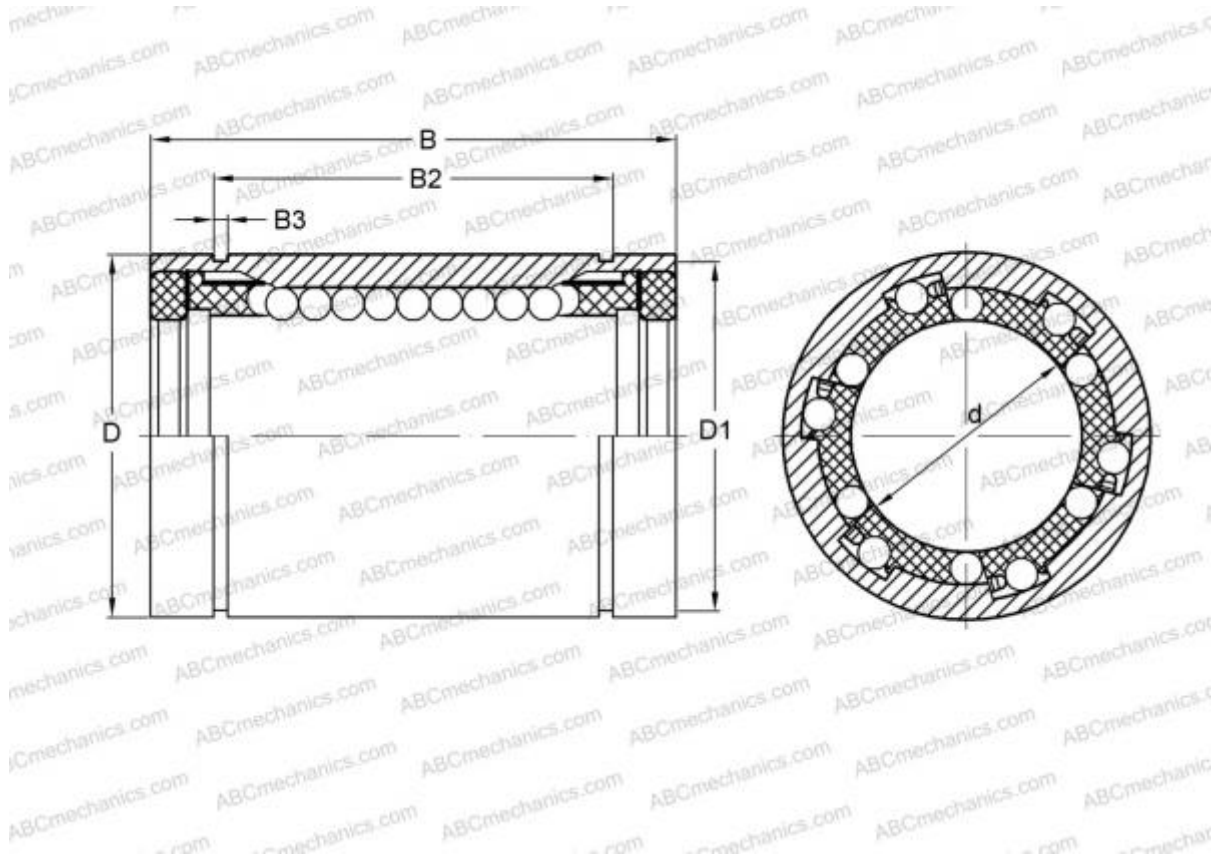

Technical specification

DIMENSIONS, MM

d	16,000
D	26,000
B	36,000
D1	24,900
B2	24,600
B3	1,300

WEIGHT, KG 0,050

MANUFACTURER [INA](#)

INTERCHANGE

ABC	LBE 16 UU
IKO	LBE 16 UU
STAR	0602-016-10
THOMSON	0602-016-10

INTERCHANGE

SKF	LBCR 16-2LS
FAG	LAA 16x26x36.2RS

REPLACES

KB 1636 PP