

LAA 20x32x45.2RS FAG

Linear bushing

TYPE: Shaft guidance systems, Linear bushing, Standard, Close type, Type LBE..UU, KB..PP, LBCR..2LS, sealed on both sides

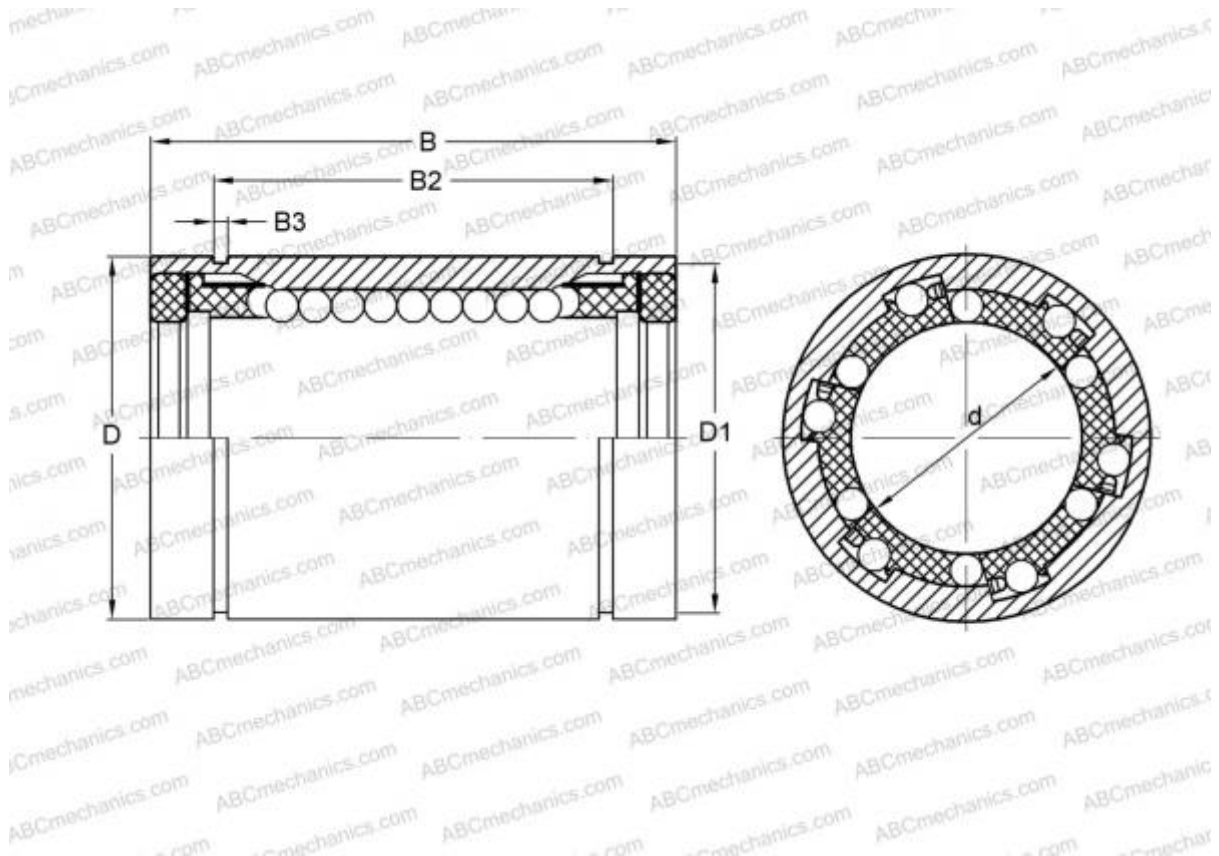

Technical specification

DIMENSIONS, MM

d	20,000
D	32,000
B	45,000

WEIGHT 0,085

MANUFACTURER [FAG](#)

INTERCHANGE

ABC	LBE 20 UU
IKO	LBE 20 UU
STAR	0602-020-10
THOMSON	0602-020-10
INA	KB20-PP
SKF	LBCR 20-2LS