

## KB25-PP INA

Linear bushing

TYPE: Shaft guidance systems, Linear bushing, Standard, Close type, Type LBE..UU, KB..PP, LBCR..2LS, sealed on both sides

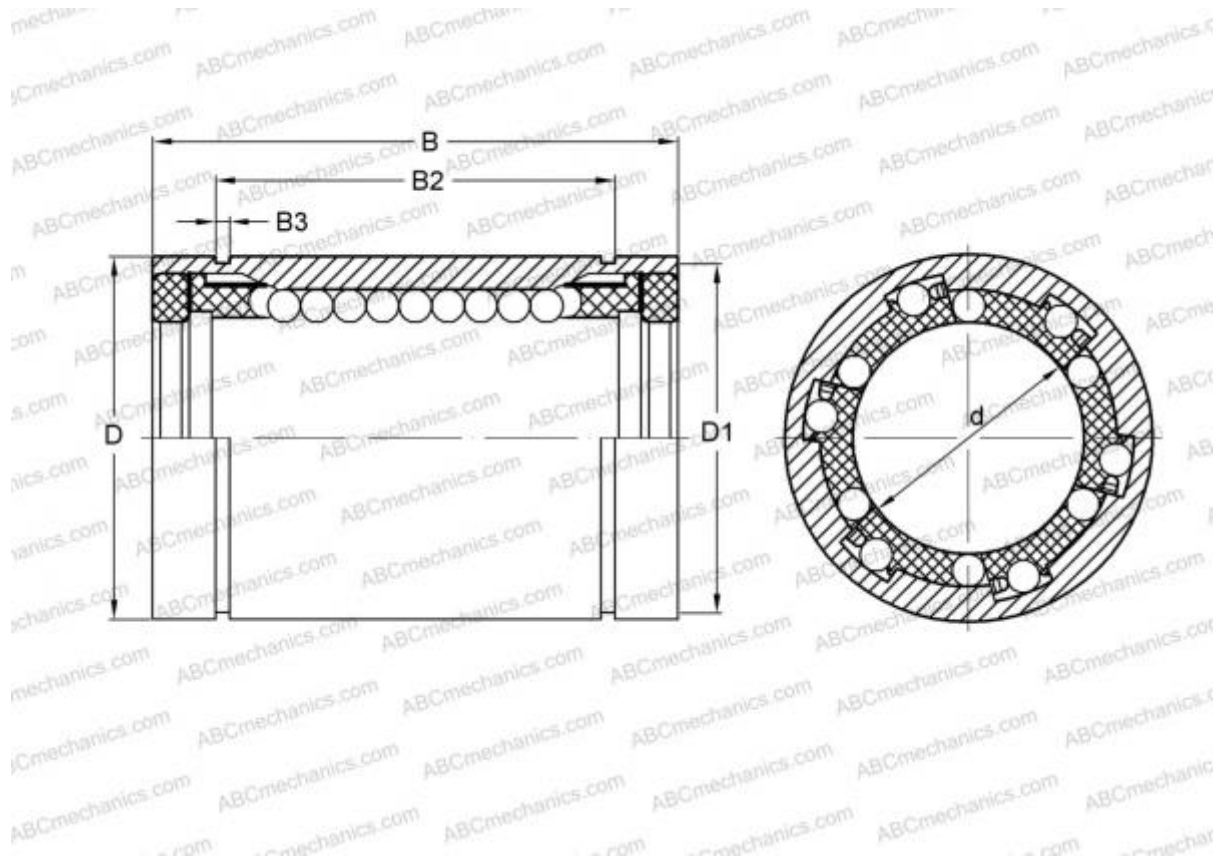

### Technical specification

#### DIMENSIONS, MM

d	25,000
D	40,000
B	58,000
D1	37,500
B2	43,700
B3	1,850

**WEIGHT, KG** 0,190

**MANUFACTURER** [INA](#)

#### INTERCHANGE

ABC	<a href="#">LBE 25 UU</a>
IKO	<a href="#">LBE 25 UU</a>
STAR	<a href="#">0602-025-10</a>
THOMSON	<a href="#">0602-025-10</a>

#### INTERCHANGE

SKF	<a href="#">LBCR 25-2LS</a>
FAG	<a href="#">LAA 25x40x58.2RS</a>

#### REPLACES

KB 2558 PP