

LAA 25x40x58.2RS FAG

Linear bushing

TYPE: Shaft guidance systems, Linear bushing, Standard, Close type, Type LBE..UU, KB..PP, LBCR..2LS, sealed on both sides

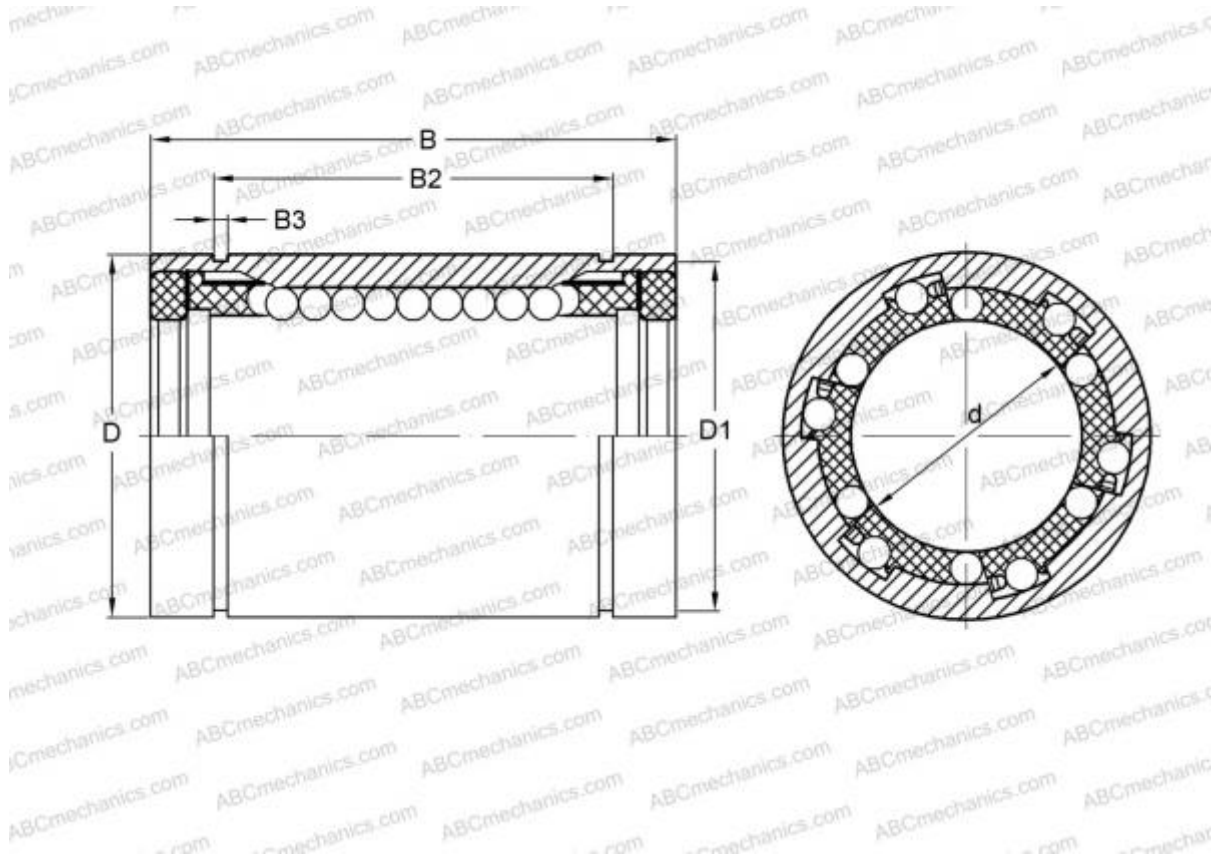

Technical specification

DIMENSIONS, MM

d	25,000
D	40,000
B	58,000

WEIGHT 0,162

MANUFACTURER [FAG](#)

INTERCHANGE

ABC	LBE 25 UU
IKO	LBE 25 UU
STAR	0602-025-10
THOMSON	0602-025-10
INA	KB25-PP
SKF	LBCR 25-2LS