

KB30-PP INA

Linear bushing

TYPE: Shaft guidance systems, Linear bushing, Standard, Close type, Type LBE..UU, KB..PP, LBCR..2LS, sealed on both sides

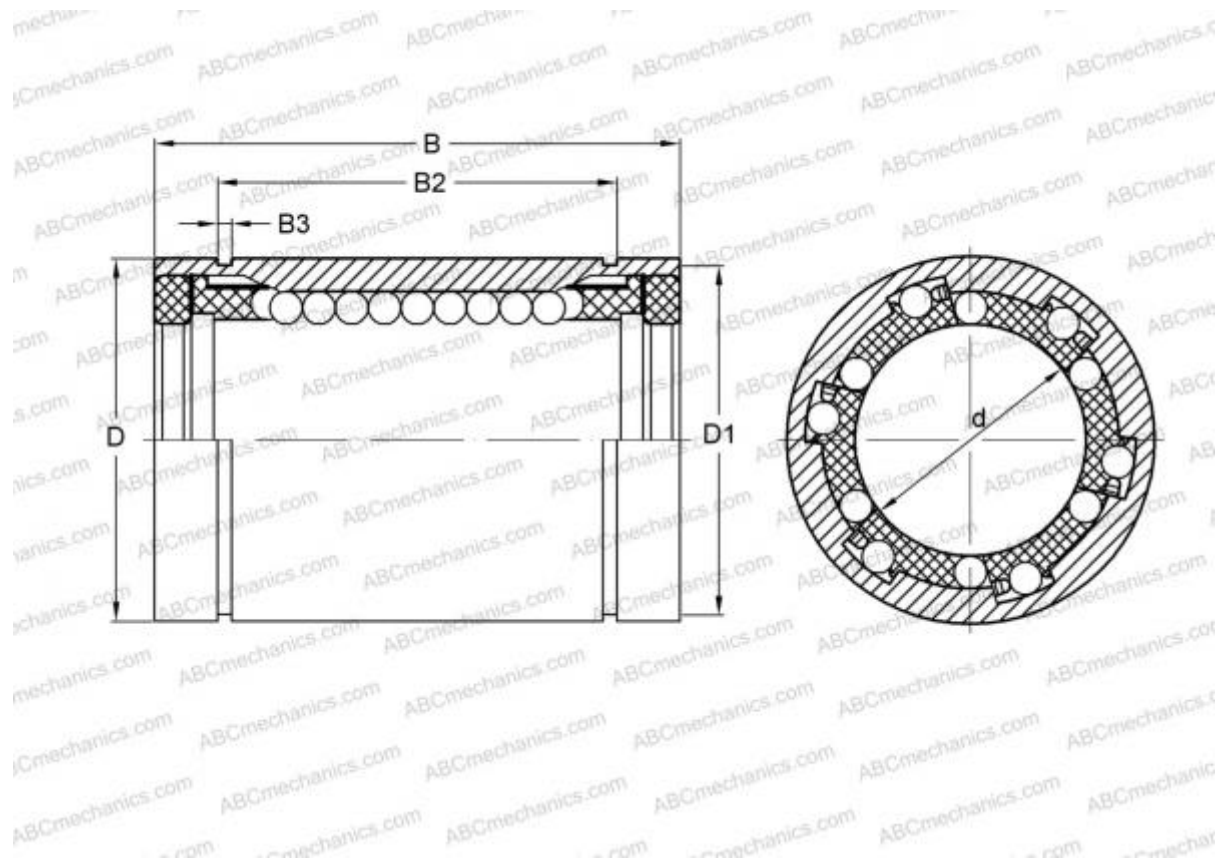

Technical specification

DIMENSIONS, MM

d	30,000
D	47,000
B	68,000
D1	44,500
B2	51,700
B3	1,850

WEIGHT, KG 0,300

MANUFACTURER [INA](#)

INTERCHANGE

ABC	LBE 30 UU
IKO	LBE 30 UU
STAR	0602-030-10
THOMSON	0602-030-10

INTERCHANGE

SKF	LBCR 30-2LS
FAG	LAA 30x47x68.2RS

REPLACES

KB 3068 PP